

File copy



Natural Resources Engineering Company

69 North 28th Street - Suite 27

Superior, Wisconsin 54880

Telephone (715) 395-5680

Fax (715) 395-5681

Paul
715-394-1576

May 21, 2004

Mr. Walt Haas
Minnesota Pollution Control Agency
1800 College Road South
Baxter, MN 56425

RE: Status Update/Feasibility Report; Enbridge South Cass Lake Pumping Station (MPCA Spill #54827), Cass Lake, Minnesota

Dear Mr. Haas:

This report documents remedial and monitoring activities conducted since submittal of the "Remedial Investigation Report" dated October 2003 to the MPCA for the above-referenced site. The present report serves to supplement the data, conclusions, and recommendations of the earlier one. A feasibility analysis is also presented which summarizes options for site cleanup. Figure 1 shows the site location, and Figure 2 depicts the layout of the station (from hereon simply referred to as the "Site").

I. Remedial Investigation Activities:

December 2003 Subsurface Investigation:

As discussed in the October 2003 submittal, four additional monitoring wells (MW-5, MW-10, MW-11 and MW-13) were installed at the Site in an effort to determine the lateral extent of crude oil present on the water table. Well construction and boring logs, as well as Minnesota Department of Health's Well and Boring Records for each well are included in Appendix A. Well depths ranged from approximately 30 to 34 feet below grade. Each well was completed with a 10-foot screen intersecting the water table. Monitoring well MW-5 was placed as close as possible to the formerly weeping flange (refer to Figure 2) without compromising the integrity of buried infrastructure. The remaining three wells were installed radially around the source area. In addition, a soil boring (B-12) was advanced approximately 55 feet northwest of the source area (refer to Figure 2 for monitoring well and soil boring locations) to a depth of 31 feet below grade.

Aquifer Hydraulics:

Groundwater elevations from all monitoring wells associated with the Site are summarized in Table 1. Figure 3 illustrates the groundwater flow regime based on heads measured in January 2004, which illustrates an easterly flow direction. Depth to groundwater across the Site varies from approximately 26 to 28 feet below ground surface. Regionally, the groundwater flow gradient is to the southeast toward Fox Creek (part of the Pike Bay drainage) with a slope of approximately 0.03%. Locally, the piezometric surface and distribution of compounds dissolved in the groundwater also indicates a southeast to east flow regime with a slope of approximately 0.07%.

Natural Resources Engineering Company

Mr. Haas
Page 2
May 21, 2004

Organic carbon content of the aquifer matrix was also analyzed from a soil sample collected at the upgradient well location (MW-1). The TOC concentration from this sample was 920 mg/kg (0.09%).

Following installation of the four additional monitoring wells, slug tests were performed on each well. Table 2 summarizes the hydraulic conductivity testing results. This table is an all-inclusive summary of slug test data collected at each monitoring well associated with the Site. The hydraulic conductivity appears to be log-normally distributed about a geometric mean of 32 feet/day. Using the hydraulic gradient of 0.07% and assuming an effective porosity typical of clean sand (0.25), the mean groundwater flow velocity was calculated at approximately 33 feet per year. Graphical results of the horizontal hydraulic conductivity analysis for monitoring wells MW-5, -10, -11 and -13 and groundwater velocity calculations are detailed in Appendix B. The velocity of crude oil and benzene were also evaluated. Benzene was chosen since this compound typically is the first to arrive on the downgradient edge of the groundwater plume and is the primary compound of concern. Assuming a kinematic viscosity of 500 cSt at 5 C (the approximate temperature of the groundwater), the velocity of crude oil in the source area is approximately 0.5 ft/year, and the velocity of benzene is approximately 21 ft/yr (retarded by a factor of 1.59). The calculations are also included in Appendix B.

The density of the crude oil varied from a minimum of 0.852 g/cm³ at MW-13 to a maximum of 0.938 g/cm³ at MW-5. The wide range in viscosity and density likely indicates the pool of crude oil present on the water table is a composite of several different crude oil batches shipped while the flange was weeping.

II. Groundwater Quality Results:

Non-Aqueous Liquid Phase:

Following well installation activities, free phase crude oil measurements were collected on three occasions. One event took place immediately following installation of the monitoring wells in December 2003 and two additional events took place in January and April 2004. Currently, four wells at the Site contain measurable thicknesses of crude oil. These are monitoring wells MW-3, -5, -11 and -13. Oil stained soil was also encountered in boring B-12 at 24.5 feet extending to the water table, which was observed at approximately 25 feet below grade. The following table is a summary of product thickness measurements collected at the Site since installation of the additional monitoring wells in December 2003.

Natural Resources Engineering Company

Mr. Haas
Page 3
May 21, 2004

| Location | Date | Crude Oil Thickness (inches) |
|----------|-------------------|------------------------------|
| MW-3 | December 17, 2003 | 8.4 |
| | January 5, 2004 | 12.8 |
| | April 2, 2004 | 8.2 |
| MW-5 | December 17, 2003 | Sheen |
| | January 5, 2004 | 17.6 |
| | April 2, 2004 | 15.0 |
| MW-11 | December 17, 2003 | 1.8 |
| | January 5, 2004 | 14.5 |
| | April 2, 2004 | 16.0 |
| MW-13 | December 17, 2003 | Sheen |
| | January 5, 2004 | 4.8 |
| | April 2, 2004 | 12.5 |

Figure 4 depicts the approximate lateral extent of free phase crude oil at the Site, as based on the presence of a smear-zone across the water table and oil measurements in monitoring wells MW-3, -5, -11 and -13.

A wide range of oil viscosities were observed between the four wells, ranging from 23 cSt at MW-13 to 421 cSt at MW-5 at 10 C. At 5 C, the viscosity of the oil is approximately 500 cSt. In combination with the shallow hydraulic gradient, the oil is virtually immobile (0.5 ft/yr). For reference, the viscosity of water at 20C is approximately 1 cSt, or over 400 times more fluid than the crude oil at the Site. A table summarizing the oil viscosity data along with graphical results depicting the relationship between viscosity and temperature are included in Appendix C. Based on the extent of the smear zone and oil thicknesses observed in the wells, it is estimated that approximately 48,000 gallons of recoverable crude oil is present on the water table (assuming an oil retention of 20%).

Dissolved Phase:

On January 5 and 6, 2004, groundwater sampling was conducted on monitoring wells MW-1, -2, -4, -5, -6, -7, -8, -9 and -10. Monitoring wells MW-3, -11 and -13 were not sampled due to the presence of crude oil. Monitoring well MW-5 contains crude oil, but a water sample was collected to quantify initial conditions for an assessment of the natural attenuation process. The water samples collected were submitted to En Chem laboratories of Superior, Wisconsin for analysis of BTEX, ERDRO and natural attenuation parameters. Each well was also analyzed for the presence of nickel and vanadium. Prior to sampling activities, the newly installed wells were developed via a vigorous bail and surge technique. Crude oil recovered from MW-5, -11 and -13 during the development process was placed in a 55-gallon drum located adjacent to monitoring well MW-3.

Tables 3, 4 and 5 are summaries of the groundwater analytical data. The complete laboratory analytical reports for the January 2004 event are included in Appendix D. Monitoring wells MW-5 and MW-10

Natural Resources Engineering Company

Mr. Haas
Page 4
May 21, 2004

were the only wells that detected crude oil related compounds with concentrations above laboratory detection limits during the January 2004 event. Wells MW-5 and MW-10 had exceedances of the Minnesota Department of Health's Health Risk Limit of 10 µg/L for benzene. Benzene concentrations ranged from a maximum of 6,500 µg/L at MW-5 to below detectable concentrations further downgradient to the southeast. The extent of benzene dissolved in the near surface aquifer is depicted on Figure 5. The maximum ERDRO concentration was 30,000 µg/L at MW-10. Nickel was detected at monitoring well MW-10 at a concentration of 14 µg/L, and was not detected in the other samples. As discussed in the previous submittal, there are no downgradient drinking water receptors within ½ - mile of the Site.

Since only one event of natural attenuation parameters have been collected, a detailed analysis cannot be performed at this time. However, early indications such as a drop in dissolved oxygen concentrations across the Site are encouraging.

III. Development of Remedial Alternatives:

The remedial action objective at the Site is to minimize the risk to human health and the environment posed by the presence of crude oil on the water table. To accomplish this objective, a variety of remedial alternatives were evaluated based on a variety of screening criteria. These criteria include the following:

- overall protection of human health and the environment;
- compliance with applicable or relevant and appropriate requirements (ARAR's);
- long-term effectiveness and permanence;
- reduction of toxicity, mobility, or volume;
- short term effectiveness;
- implementability;
- cost; and
- State and community acceptance.

To aid the selection process, a present worth analysis was performed for each individual technology. Costs were taken from actual equipment, labor, and power costs as well as the *RS Means Site Work & Landscape Cost Data 21st Annual Edition* reference manual. These costs are detailed on Table 6 and the present worth is summarized with each remediation technology discussed below. Table 6 also illustrates the anticipated life of each technology. The following is a discussion of the remedial technologies that were screened.

Natural Resources Engineering Company

Mr. Haas
Page 5
May 21, 2004

A. Natural Attenuation Monitoring

In this approach, a study of natural loss mechanisms such as decay and volatilization would be made to assess the effectiveness in reducing crude oil compounds dissolved in the groundwater to safe levels. There are no private drinking water wells located within ½-mile downgradient of the Site. Therefore, advantages to this approach are that there are no nearby risk receptors, and no equipment or installation costs would be involved. The drawback is the long period of time required to achieve the clean up goal. The present worth of this option is \$35,000. Since this option does not produce short-term results and is not an aggressive oil recovery technology, it is not considered a feasible option for the Site when taken on its own. Rather, natural attenuation would have to be considered in conjunction with a source area removal or isolation technology.

B. Crude Oil Recovery Technologies

As removal of oil down to a sheen would be the likely clean-up goal for the Site, the presence of high viscosity oil (500 cSt) at MW-5 will dictate the life of the clean-up. As such, it is assumed that subsurface conditions at the Site would yield approximately 0.25 gallon/day from a 2-inch diameter monitoring well. Assuming approximately 48,000 gallons of recoverable crude oil are available, it would take greater than 100 years to achieve the required clean up goal. Rather than utilize the existing monitoring wells at the Site, it is assumed that four 10-inch diameter recovery wells would be installed.

- Pump and Treat:

Pump and treatment of residual crude oil was an option considered at the Site. Although this technology has been proven effective at recovering low viscosity crude oil from the water table at other locations, it would not be considered effective remedy in this situation. Given the fact that much of the residual crude oil is considered immobile due to its high viscosity (500 cSt), an impractical amount of water would have to be pumped (greater than 200 gallons per minute per well) to achieve a great enough drawdown (approximately 30 feet) to mobilize the crude oil for recovery from the well. Therefore, given the viscosity of the crude oil, this is not considered an implementable or cost effective option and does not pass the screening criteria outlined at the beginning at this section.

- Magnum Spill Buster Pump:

Clean Earth Technologies, Inc. has developed a pumping system known as the Magnum Spill Buster (MSB) for recovering petroleum products. This system incorporates an electric skimmer pump and reel system which automatically seeks and follows the water/crude oil interface in a 2-inch diameter or larger well. The system can be easily installed in the existing monitoring wells at the Site. A 110 volt AC power source would be required.

Advantages to this system are that it requires minimal maintenance and automatically tracks the water table. Maintenance of the system involves cleaning the pump intake filter with toweling, soap and

Natural Resources Engineering Company

Mr. Haas
Page 6
May 21, 2004

water. Drawbacks to the MSB system are that it is not effective in pumping oil with a viscosity greater than approximately 30 cSt and that pump performance cannot be monitored remotely.

Since oil viscosities across the Site range from approximately 30-500 cSt, this system is not considered implementable for the Site.

- Flexible Axial Peristaltic (FAP) System:

The FAP system is an automated crude oil recovery skimming system that may be fitted to 2-inch diameter or larger wells. This system consists of a flexible, inner bladder and a flexible hose that forms the outer bladder. The pump operates by alternatively inflating and deflating the annular space between the inner bladder and the outer hose. When compressed air is applied, the inner bladder collapses. When the air is exhausted, the inner bladder rebounds to its original shape. This causes a suction that pulls fluid into the pump. When air pressure is re-applied, a check valve at the bottom of the pump closes. As the inner bladder is compressed, the contained fluid opens a second check valve at the top of the pump and the fluid is directed to the surface.

The advantages of this system are that it recovers only product and may be applied in 2-inch or larger diameter wells. The drawback is that this type of system may be labor intensive and would not be able to recover high viscosity oil which is present at the Site.

Since this system is not effective in recovering high viscosity oil, it is not considered implementable, and therefore not a feasible option.

- Electric Belt Skimmers:

Belt skimmers operate by rotating an oil-absorbent belt through the water/crude oil interface up to a scraper system where oil is recovered from the belt and transferred to a collection unit. Belt skimmers can achieve removal rates of up to 12 gallons per hour, which is more than enough given the yield of the formation at the Site. These devices are also capable of recovering high viscosity oil. The belt skimmers from Abanaki can be used for a variety of materials with a varying belt type and for a variety of well sizes down to 2-inches in diameter. One particular type of belt skimmer from Abanaki is a system referred to as the PetroXtractor. This type of skimmer is driven by either electric power or compressed air and is designed to be retrofitted to a 2-inch diameter or larger well.

Drawbacks to these devices are that they may require regular maintenance and non-extreme temperature conditions. The effluent from the skimmer may be high in water content, and may present operational difficulties during freezing conditions.

The present worth of this system, assuming operation of a belt skimmer in four recovery wells is approximately \$933,000. Since this system passed each of the screening criteria, it is considered a feasible option for the Site.

Mr. Haas
Page 7
May 21, 2004

- Passive Skimmers:

Passive skimmers were also considered for this Site. These devices are simply canisters that are placed in the well that passively collect oil. The primary advantages to these types of systems are the speed and ease of installation. However, they are only effective at sites with minimal amounts of crude oil. Given the product thicknesses at the Site, and based on the collection capacities of these devices, a significant amount of on-site labor hours would be required.

Since this technology cannot produce short-term results and is not cost effective, it is not considered feasible for the Site.

C. Excavation of Crude Oil Impacted Soil

Excavation of oily soils and recovery of free product is an approach that was considered at the Site. It is estimated that approximately 2,500 cubic yards of crude oil impacted soil would need to be removed and treated. To access impacted soil, a total of approximately 17,000 cubic yards of clean soil would have to be moved. This was calculated based on the smear-zone extent depicted on Figure 4 as well as smear-zone thicknesses from the push probes, soil borings and monitoring wells at the Site.

The advantage to this option is that it is a short term, aggressive method in which impacted soil as well as free product is removed, and there are no long term operating and maintenance costs. The drawback is the difficulty excavating with the large amount of buried infrastructure at the Site, and the inherent risk to the pipeline system integrity such an excavation would create. Figure 6 illustrates the extent of buried infrastructure at the Site.

The cost of this option is approximately \$251,000. This cost includes the use of sheet piling given the depth to the oil/water interface is approximately 28 feet below grade, and also takes into consideration intangible items dealing with property access issues with Burlington Northern Railroad. Since this is not an implementable technology given the depth to the oil/water interface, large amount of buried infrastructure and potential risk to the pipeline transmission system, it is not considered a feasible option.

D. Increased Oil Mobility Technologies

The technologies discussed below focus on changing the chemical and physical behavior of the crude oil as a means to increase mobilization to existing monitoring wells or future recovery wells. Since increased mobility would allow for more efficient oil recovery, it is assumed that the anticipated time required to achieve the clean up goal would decrease. In conjunction with the technologies discussed below, it is assumed that a recovery system/device would also be utilized due to the increased oil mobility. The following technologies were considered:

Natural Resources Engineering Company

Mr. Haas
Page 8
May 21, 2004

- Surfactants:

In an effort to overcome interfacial tension which traps crude oil in the subsurface, surfactants (such as soaps and foams) can be incorporated into the aquifer. These technologies decrease the viscosity of the oil, thereby making it more fluid. A drawback to this technology is the complexity in getting regulatory approval to add any "foreign material" into the subsurface. Per conversations with the Well Management Section of the Minnesota Department of Health (MDH), a variance must be applied for prior to adding any foreign substance into the subsurface. At which time, the MDH will make a decision as to whether or not the substance is appropriate to add to the aquifer. Per information from the MDH, there is no set of written rules or regulations that discusses which substances may or may not be added to the subsurface. This is decided on by the MDH on a case by case basis.

Since this option may not meet the ARARs or State acceptance criteria, it is not considered feasible at this time.

- Thermal Treatment (Steam Injection):

Addition of steam to the crude oil in the subsurface will reduce the viscosity of oil and enhance its mobility to nearby recovery wells. This technology was screened using a mobile steam injection system. With a mobile system, augers equipped with steam injection nozzles are injected downward into the soil. Low-moisture-content steam is injected in to the aquifer and diffuses in the groundwater and heat is exchanged. Assuming the steam would heat the water to 20 C, the time required to achieve the clean up goal would be on the order of approximately 82 years.

The advantage to this type of technology is that the viscosity of crude oil would be reduced. The drawbacks to this system are that buried infrastructure in the area may have a significant impact on the effectiveness of the system, and the system would involve large energy requirements.

The present worth of this option is approximately \$522,000. Due to the significant amount of buried infrastructure in the area, this technology is not considered a feasible option at the Site.

E. Plume Stabilization

- Sheet Piling Containment Wall

Another option being considered is to stabilize/contain the product plume by encompassing the downgradient and sidegradient edges with sheet piling, thereby partially penetrating the near surface aquifer. This option provides containment and does not address removal of residual crude oil. It is assumed that the sheet piling would be advanced to a depth of approximately 5 feet below the water table. This would allow oil to be contained taking into account water table fluctuations, and would not greatly impede the flow of groundwater across the Site. In addition, two monitoring wells would be installed along the open edges of the containment wall to provide detection monitoring points to ensure

Natural Resources Engineering Company

Mr. Haas
Page 9
May 21, 2004

that residual oil is in fact being contained. The capital costs to install sheet piling and two wells and costs to operate the system would be approximately \$230,000. This cost includes subcontractor and installation oversight costs as well as intangible items such as obtaining property access from the Burlington Northern Railroad. This cost assumes approximately 8,750 ft² of sheet piling would be installed. Since this option passes each of the screening criteria, it was considered feasible for the Site.

- Interceptor Trench

In conjunction with the sheet piling containment wall discussed above, installation of an interceptor trench was also considered for the Site. The trench would be installed parallel to the Burlington Northern railroad tracks and would be approximately 250 feet long by six feet wide to a depth of approximately 30 feet. A four foot diameter drain tile would be installed in the trench and set with coarse aggregate material. During installation, it is assumed that approximately 100 cubic yards of crude oil impacted soil would be removed and hauled off site for disposal. The total cost to install and operate this system would be approximately \$541,000. This includes subcontractor and installation oversight as well as soil excavation, hauling and disposal.

Due to the close proximity of the Burlington Northern Railroad, and implementability issues, this technology is not considered a feasible option at the Site.

F. Enhanced Biological Degradation

Placement of oxygen releasing compounds (ORC) and or other nutrients (molasses) was also screened. This type of technology is cheap and easy to implement. However, it is only applicable at sites that have minimal amounts of crude oil. This type of technology is generally not applicable to sites that have greater than 1-inch of product present on the water table. In addition, special permits would likely be required prior to adding foreign material to the subsurface.

Since this option does not produce short term results and is not capable of achieving the desired cleanup goal within a reasonable period of time, it is not considered feasible.

IV. Focused Screening of Remedial Alternatives

Remedial technologies discussed below appear to be the most feasible for the South Cass Lake site based on protection of human health and the environment, and compliance with the technology screening criteria. The following are the technologies that passed the screening process.

- Natural Attenuation:

Given the fact that there are no nearby risk receptors, and no equipment or installation costs, this option was considered. The present worth of this option is \$35,000. This option is not considered feasible for

Natural Resources Engineering Company

Mr. Haas
Page 10
May 21, 2004

the Site when taken on its own. Rather, natural attenuation would have to be considered in conjunction with a source area removal or isolation technology. Although a complete assessment of the effectiveness of natural attenuation at the Site is premature, initial indications of biological activity across the Site (changes in dissolved oxygen) are encouraging.

- Belt Skimmers:

Given the high viscosity oil present at the Site, it appears that belt skimmers would be the most appropriate active recovery system utilizing 10-inch diameter recovery wells. Each system would be equipped with an automatic high level shut off switch. Vandalism would not be of concern since each system would be installed inside the fenced-in portion of the station yard. It is assumed that bi-weekly site visits will be conducted following initial installation of the system. This may be reduced depending on system performance. The present worth of this system, assuming operation of a belt skimmer in four recovery wells for a time period of 100 years is approximately \$933,000.

- Plume Containment (Sheet Piling):

Another option considered feasible is to stabilize/contain the product plume by installing sheet piling along the downgradient and sidegradient edges of the pool of oil. This technology takes advantage of the fact that the oil is less dense than water, and as such, the sheet pile would only have to partially penetrate the aquifer. Given the observed water table fluctuations, thickness of oil, and smear-zone, the sheet pile would need to be advanced approximately five feet beneath the water table to ensure containment. Given the buried infrastructure and potential land access issues, the sheet pile may need to be configured in a slightly arced or funneled geometry. As the sheet pile allows groundwater flow to pass beneath, and is not closed, pumping may not be required. In addition, two monitoring wells would be installed along the open edges of the containment wall and checked on a regular basis to ensure that residual oil is in fact being contained. These wells would be monitored for the presence of crude oil on a semi-annual basis in perpetuity. The present worth of this option would be approximately \$230,000. This includes subcontractor and installation oversight as well as soil excavation, and oily soil hauling and disposal.

- Thermal Treatment (Steam Injection):

Steam injection is an option selected due to the ability of increasing oil mobility rates to the wells. This in turn will allow for more efficient recovery, thereby reducing the anticipated time to achieve the cleanup goal. Given the amount of buried infrastructure at the site, it is proposed that a pilot study be conducted prior to implementation, and based on the findings, would most likely compliment an active oil recovery system. The present worth of this technology is approximately \$522,000.

V. Conclusions and Recommendations for Future Activities:

- Conclusions:

The following are conclusions based on the results of the feasibility study and current conditions at the Site:

- The hydraulic conductivity across the Site appears log-normally distributed about a geometric mean of 32 feet/day;
- The mean groundwater flow velocity is approximately 33 feet per year toward the east/southeast, and there are no downgradient drinking water receptors within ½ - mile of the Site;
- Benzene is the primary compound of concern dissolved in the groundwater, and the transport velocity in the aquifer is approximately 21 ft/yr (retarded by a factor of 1.59);
- Crude oil is present in four monitoring wells (MW-3, -5, -11 and -13), and ranges in thickness from 8 to 16 inches. This represent a volume of approximately 48,000 gallons of crude oil;
- Oil viscosities at the Site range from approximately 30 cSt along the perimeter of the product plume (MW-13) to 500 cSt near the source area (MW-5). For reference, the viscosity of water is approximately 1 cSt, or over 400 times more fluid than crude oil at the Site;
- The crude oil in the vicinity of the source area is virtually immobile, having a velocity of approximately 0.5 ft/year;
- The density of the crude oil varied from a minimum of 0.852 g/cm³ at MW-13 to a maximum of 0.938 g/cm³ at MW-5. The wide range in viscosity and density likely indicates the pool of crude oil present on the water table is a composite of several different crude oil batches shipped while the flange was weeping;
- Given the extremely high viscosity and slow flow rate, traditional oil recovery technologies such as pump and treat are not feasible;
- Excavation, although a short-term, aggressive remedial technology, is not considered a feasible option given the depth and significant amount of buried infrastructure at the Site.

Natural Resources Engineering Company

Mr. Haas
Page 12
May 21, 2004

- Recommendations:

The primary objective at the Site is to minimize the risk to human health and the environment posed by the presence of crude oil floating on the water table. Given the fact that the residual crude oil is considered essentially immobile (approximately 0.5 ft/yr), and the complexity of buried infrastructure at the Site, active recovery technologies are not considered feasible. There are no drinking water wells within a ½-mile hydraulically downgradient of the Site and the nearest surface water body is Spike Lake, which is located approximately ½-mile southwest and hydraulically upgradient of the Site. Based on the findings of the focused feasibility study, and in compliance with the objectives at the Site, it is recommended that a partially penetrating sheet piling containment wall be installed along the downgradient and sidegradient edges of the product plume. To make certain the crude oil is in fact contained with this alternative, monitoring for oil in two additional wells strategically placed at the open edges of the barrier will be performed. This option provides isolation of the crude oil source area. In conjunction with this isolation technology, an analysis of natural attenuation as an effective remedy to minimize the risk posed by dissolved phase crude oil constituents, which may be released into the groundwater from the stationary crude oil source area, should be evaluated. To accomplish this, natural attenuation parameters will be evaluated on a quarterly basis in five of the monitoring wells along the centerline of the groundwater plume. These include an upgradient well (MW-1), source area well (MW-5), and three downgradient wells (MW-8, -9 and -10).

The wells will be analyzed for the following parameters:

- Dissolved oxygen;
- Nitrate;
- Ferrous iron;
- Sulfate;
- Methane;
- pH;
- Temperature;
- Depth to groundwater; and
- ERDRO and BTEX.

Hydraulic information (depth to groundwater and oil thickness measurements) will also be collected from the remaining wells at the Site (MW-2, -3, -4, -6, -7, -11 and -13) on a quarterly basis.

This combination of the isolation and natural attenuation remedies meets each of the screening criteria, and we request the MPCA approve this option.

Natural Resources Engineering Company

Mr. Haas
Page 13
May 21, 2004

Please let me know if you have any comments or questions -- I can be reached at (715) 395-5680 Ext 150.

Sincerely,
Natural Resources Engineering Company

Barry Power, P.E. *enr*

Barry Power, P.E.
Environmental Engineer

- cc: Paul Meneghini / Mark Sitek – Enbridge: Superior Region
John Aho – MPCA
- bc: EEC Law Department

TABLES

Table 1: Groundwater Elevations
Enbridge Pipelines (Lakehead), L.L.C. - South Cass Lake Station

| Well | Date | Top of Inner Casing * | Depth to Groundwater (feet) | Depth to Oil (feet) | Oil Thickness (feet) | Equivalent Depth to Groundwater (feet) | Groundwater Elevation |
|-------|-----------|-----------------------|-----------------------------|---------------------|----------------------|--|-----------------------|
| MW-1 | 06-Jun-01 | 100.00 | 26.29 | | | | 73.71 |
| | 10-May-02 | | 27.57 | | | | 72.43 |
| | 14-May-02 | | 27.60 | | | | 72.40 |
| | 21-Jul-03 | | 28.07 | | | | 71.93 |
| | 06-Jan-04 | | 28.50 | | | | 71.50 |
| | 02-Apr-04 | | 28.53 | | | | 71.47 |
| MW-2 | 06-Jun-01 | 99.57 | 25.87 | | | | 73.70 |
| | 10-May-02 | | None Recorded | | | | |
| | 14-May-02 | | 27.25 | | | | 72.32 |
| | 21-Jul-03 | | 27.71 | | | | 71.86 |
| | 06-Jan-04 | | 28.12 | | | | 71.45 |
| | 02-Apr-04 | | 28.11 | | | | 71.46 |
| MW-3 | 06-Jun-01 | 99.60 | 25.92 | 25.32 | 0.60 | 25.37 | 74.23 |
| | 10-May-02 | | 27.19 | 26.51 | 0.68 | 26.57 | 73.03 |
| | 14-May-02 | | 27.22 | 26.6 | 0.62 | 26.66 | 72.94 |
| | 21-Jul-03 | | 28.30 | 27.77 | 0.53 | 27.82 | 71.78 |
| | 5-Jan-04 | | 29.12 | 28.05 | 1.07 | 28.15 | 71.45 |
| | 2-Apr-04 | | 28.77 | 28.09 | 0.68 | 28.15 | 71.45 |
| | | | | | | | |
| MW-4 | 06-Jun-01 | 100.39 | 26.68 | | | | 73.71 |
| | 10-May-02 | | 27.92 | | | | 72.47 |
| | 14-May-02 | | 27.96 | | | | 72.43 |
| | 21-Jul-03 | | 28.35 | | | | 72.04 |
| | 06-Jan-04 | | 28.75 | | | | 71.64 |
| | 02-Apr-04 | | 28.80 | | | | 71.59 |
| MW-5 | 05-Jan-04 | 99.58 | 29.65 | 28.18 | 1.47 | 28.27 | 71.31 |
| | 2-Apr-04 | | 29.72 | 28.47 | 1.25 | 28.55 | 71.03 |
| MW-6 | 21-Jul-03 | 100.71 | 28.75 | | | | 71.96 |
| | 06-Jan-04 | | 29.05 | | | | 71.66 |
| | 02-Apr-04 | | 29.15 | | | | 71.56 |
| MW-7 | 21-Jul-03 | 99.83 | 28.09 | | | | 71.74 |
| | 06-Jan-04 | | 28.34 | | | | 71.49 |
| | 02-Apr-04 | | 28.43 | | | | 71.40 |
| MW-8 | 21-Jul-03 | 101.00 | 29.37 | | | | 71.63 |
| | 06-Jan-04 | | 29.70 | | | | 71.30 |
| | 02-Apr-04 | | 29.77 | | | | 71.23 |
| MW-9 | 21-Jul-03 | 98.25 | 26.41 | | | | 71.84 |
| | 21-Jul-03 | | 26.79 | | | | 71.46 |
| | 02-Apr-04 | | 26.81 | | | | 71.44 |
| MW-10 | 05-Jan-04 | 99.66 | 28.38 | | | | 71.28 |
| | 2-Apr-04 | | 28.30 | | | | 71.36 |
| MW-11 | 17-Dec-04 | 99.99 | 28.66 | 28.5 | 0.16 | 28.51 | 71.48 |
| | 05-Jan-04 | | 29.70 | 28.49 | 1.21 | 28.60 | 71.39 |
| | 2-Apr-04 | | 29.78 | 28.45 | 1.33 | 28.57 | 71.42 |
| MW-13 | 05-Jan-04 | 101.02 | 29.92 | 29.52 | 0.40 | 29.58 | 71.44 |
| | 2-Apr-04 | | 30.57 | 29.53 | 1.04 | 29.68 | 71.34 |

* Note: Elevation assumed as 100.00' at monitoring well MW-1 at the top of the north side of the inner casing.

**Table 2: Hydraulic Conductivity Values
Enbridge Energy Company - South Cass Lake Station**

| Well | Hydraulic Conductivity (feet/day) | Comments |
|--------------------------|--|-----------------|
| MW-1 | 4.0 | Dissipation |
| MW-1 | 13.2 | Recovery |
| MW-2 | 19.8 | Dissipation |
| MW-2 | 27.6 | Recovery |
| MW-3 | 9.7 | Dissipation |
| MW-3 | 27.6 | Recovery |
| MW-4 | 17.4 | Dissipation |
| MW-4 | 24.5 | Recovery |
| MW-5 | 33.9 | Dissipation |
| MW-5 | 29.8 | Recovery |
| MW-6 | 33.6 | Recovery |
| MW-7 | 15.7 | Dissipation |
| MW-7 | 15.4 | Recovery |
| MW-8 | 27.4 | Dissipation |
| MW-8 | 16.8 | Recovery |
| MW-10 | 220.3 | Dissipation |
| MW-10 | 202.2 | Recovery |
| MW-11 | 55.0 | Dissipation |
| MW-11 | 55.0 | Recovery |
| MW-13 | 149.4 | Dissipation |
| MW-13 | 174.7 | Recovery |
| Arithmetic Mean = | 55.9 | feet/day |
| Geometric Mean = | 32.1 | feet/day |

**Table 3: Groundwater Sampling Results - BTEX and ERDRO
Enbridge Pipelines (Lakehead), L.L.C. - South Cass Lake Station**

| Location | Date | Benzene (ug/l) | Ethylbenzene (ug/l) | Toluene (ug/l) | Xylenes, -m, -p (ug/L) | Xylenes, -o (ug/L) | ERDRO (ug/L) |
|-----------------------------|-----------|-------------------|------------------------|------------------------------|---------------------------|-----------------------|-----------------|
| Health Risk Limit (ug/L) | | 10 | 700 | 1,000 | 10,000 | | |
| MW-1 | 6/6/2001 | < 1.0 | < 1.0 | < 1.0 | < 2.0 | < 1.0 | < 100 |
| MW-1 | 7/16/2003 | < 1.0 | < 1.0 | < 1.0 | < 2.0 | < 1.0 | < 100 |
| MW-1 | 1/6/2004 | < 1.0 | < 1.0 | < 1.0 | < 2.0 | < 1.0 | < 110 |
| MW-2 | 6/6/2001 | < 1.0 | < 1.0 | < 1.0 | < 2.0 | < 1.0 | < 100 |
| MW-2 | 7/16/2003 | < 1.0 | < 1.0 | < 1.0 | < 2.0 | < 1.0 | < 100 |
| MW-2 | 1/6/2004 | < 1.0 | < 1.0 | < 1.0 | < 2.0 | < 1.0 | < 100 |
| MW-4 | 6/6/2001 | < 1.0 | < 1.0 | < 1.0 | < 2.0 | < 1.0 | < 100 |
| MW-4 | 7/16/2003 | < 1.0 | < 1.0 | < 1.0 | < 2.0 | < 1.0 | < 100 |
| MW-4 | 1/6/2004 | < 1.0 | < 1.0 | < 1.0 | < 2.0 | < 1.0 | < 100 |
| MW-5 | 1/6/2004 | 6,500 | 530 | <50 | 1,800 | <50 | |
| MW-6 | 7/16/2003 | < 1.0 | < 1.0 | < 1.0 | < 2.0 | < 1.0 | < 100 |
| MW-6 | 1/6/2004 | < 1.0 | < 1.0 | < 1.0 | < 2.0 | < 1.0 | < 100 |
| MW-7 | 7/16/2003 | < 1.0 | < 1.0 | < 1.0 | < 2.0 | < 1.0 | < 100 |
| MW-7 | 1/6/2004 | < 1.0 | < 1.0 | < 1.0 | < 2.0 | < 1.0 | < 100 |
| MW-8 | 7/16/2003 | < 1.0 | < 1.0 | < 1.0 | < 2.0 | < 1.0 | < 100 |
| MW-8 | 1/6/2004 | < 1.0 | < 1.0 | < 1.0 | < 2.0 | < 1.0 | < 100 |
| MW-9 | 7/16/2003 | 0.51 | < 1.0 | < 1.0 | < 2.0 | < 1.0 | < 100 |
| MW-9 | 1/6/2004 | <1.0 | < 1.0 | < 1.0 | < 2.0 | < 1.0 | < 100 |
| MW-10 | 1/5/2004 | 1,100 | 110 | <5.0 | 520 | <5.0 | 30,000 |
| GP-3 | 9/25/2001 | 340 | < 1.0 | < 1.0 | < 2.0 | < 1.0 | < 160 |
| GP-4 | 9/25/2001 | 1,300 | 230 | < 10 | < 20 | < 10 | 830 |
| GP-5 | 9/25/2001 | < 1.0 | < 1.0 | < 1.0 | < 2.0 | < 1.0 | < 180 |
| GP-6 | 9/25/2001 | < 1.0 | < 1.0 | < 1.0 | < 2.0 | < 1.0 | < 160 |
| GP-10 | 9/26/2001 | < 1.0 | < 1.0 | < 1.0 | < 2.0 | < 1.0 | < 160 |
| GP-15 | 9/26/2001 | < 1.0 | < 1.0 | < 1.0 | < 2.0 | < 1.0 | < 160 |
| GP-16 | 9/26/2001 | 19 | < 1.0 | < 1.0 | < 2.0 | < 1.0 | < 160 |
| GP-17 | 8/14/2002 | | | | | | < 230 |
| GP-18 | 8/14/2002 | < 1.0 | < 1.0 | < 1.0 | < 2.0 | < 1.0 | < 250 |
| GP-19 | 8/14/2002 | | | | | | < 220 |
| GP-20 | 8/13/2002 | | | | | | < 230 |
| Trip Blank | 7/16/2003 | <1.0 | < 1.0 | < 1.0 | < 2.0 | < 1.0 | |
| Trip Blank | 1/6/2004 | | | Froze during sampling event. | | | |

Table 4: Groundwater Sampling Results: Natural Attenuation Parameters¹
Enbridge Pipelines (Lakehead), L.L.C. - South Cass Lake Station

| Location | Collection Date | Nitrate (mg/L) | Sulfate (mg/L) | Disolved Oxygen (mg/L) | Fe ⁺² (mg/L) |
|----------|-----------------|----------------|----------------|------------------------|-------------------------|
| MW-1 | 7/16/2003 | | | 5.4 | <0.1 |
| | 1/6/2004 | 2.1 | 6.3 | 5.2 | <0.1 |
| MW-2 | 7/16/2003 | | | 4.1 | <0.1 |
| | 1/6/2004 | 4.1 | < 4.0 | 4.5 | <0.1 |
| MW-4 | 7/16/2003 | | | 3.8 | <0.1 |
| | 1/6/2004 | 1.0 | < 4.0 | 5.5 | <0.1 |
| MW-6 | 7/16/2003 | | | 2 | <0.1 |
| | 1/6/2004 | 1.9 | 5.4 | 2.6 | <0.1 |
| MW-7 | 7/16/2003 | | | 3.4 | <0.1 |
| | 1/6/2004 | < 0.25 | 5.7 | 4.3 | <0.1 |
| MW-8 | 7/16/2003 | | | 2.5 | <0.1 |
| | 1/6/2004 | 0.34 | 5.5 | 2.8 | <0.1 |
| MW-9 | 7/16/2003 | | | 2.8 | <0.1 |
| | 1/6/2004 | < 0.25 | 6.3 | 2 | <0.1 |
| MW-10 | 1/5/2004 | < 0.25 | < 4.0 | 1.5 | <0.1 |

Notes

¹ Analyses performed by EnChem Inc. unless otherwise noted

**Table 5: Groundwater Sampling Results: Nickel and Vanadium¹
 Enbridge Pipelines (Lakehead), L.L.C. - South Cass Lake Station**

| Location | Collection Date | Nickel (ug/L) | Vanadium (ug/L) |
|----------|-----------------|---------------|-----------------|
| MW-1 | 1/6/2004 | < 3.0 | 3.7 |
| MW-2 | 1/6/2004 | < 3.0 | 5.0 |
| MW-4 | 1/6/2004 | < 3.0 | < 3.0 |
| MW-6 | 1/6/2004 | < 3.0 | 3.1 |
| MW-7 | 1/6/2004 | < 3.0 | < 3.0 |
| MW-8 | 1/6/2004 | < 3.0 | 3.9 |
| MW-9 | 1/6/2004 | < 3.0 | 3.9 |
| MW-10 | 1/5/2004 | 14 | 3.8 |

Notes

¹ Analyses performed by EnChem Inc. unless otherwise noted

Table 6: Present Worth Analysis of Crude Oil Recovery Technologies
Enbridge Pipelines (Lakehead), L.L.C. - South Cass Lake Station

| Technology | Advantages | Disadvantages | Equipment Capital and Installation Costs | Annual Operating Costs* | Anticipated Life (Yrs) | Present Worth (2004) |
|--|---|---|--|-------------------------|------------------------|------------------------------|
| A. Natural Attenuation | No nearby receptors at risk No equipment and installation costs | Long period of time to achieve clean-up goals | \$0 | \$17,500 | 2 | \$35,000 |
| B. Crude Oil Recovery Technologies Pump and Treat | Aggressive oil recovery technology Easy installation in the existing monitoring wells Low maintenance Automatically seeks the water table Product only pump, eliminating mixing problems May be used in 2-inch or larger wells | Not feasible given oil viscosities at the Site No remote monitoring of the system Cannot pump viscous liquids (> 28.5 cSt) | \$97,400 \$31,152 | \$24,570 \$21,258 | 100 100 | Not feasible Not feasible |
| FAP Skimmer/Pump System | Product only recovery system Can be used with existing 2-inch monitoring wells | May require increased maintenance Cannot be monitored remotely | \$23,600 | \$20,880 | 100 | Not feasible |
| Electric Bell Stimmers | Can be used with existing 2-inch monitoring wells Capable of recovering higher viscosity oil Easy installation | Effluent may contain a high water content Potentially labor intensive Operation may be difficult during freezing conditions | \$27,316 | \$21,086 | 100 | \$933,145 |
| Passive Stimmers | Can be used with existing 2" monitoring wells Maintains skimming efficiency with fluctuating water table Easy monitoring with minimal maintenance May be easily carried by wind (portable) | Low collection capacities (~ 600 mt) High amount of on-site man hours to empty/maintain canisters | \$3,600 | \$182,180 | 100 | Not feasible |
| C. Excavation Excavation (Landfill Disposal) | Remove impacted soil as well as free product No long-term operating and maintenance costs | Difficult digging with buried infrastructure High costs for excavation, hauling, and disposal Monitoring would still need to be performed Large amount of digging to reach oil/water interface Sheet piling required due to excavation depths | \$251,120 | \$0 | 1 | Not feasible |
| D. Increased Oil Mobility Technologies Surfactants | Decrease oil viscosity resulting in more efficient recovery Easy installation Increases oil mobility to the monitoring wells | Complexity of getting regulatory approval Some surfactants are considered "experimental" | \$5,000.00 | \$19,950 | 82 | Not feasible |
| Thermal Treatment (Steam Injection) | Take advantage of the physical properties of crude oil Increases oil mobility to the existing monitoring wells Eliminates heat loving bacteria that consume contaminants | Complexity of getting regulatory approval Some methods are still "experimental" Injection wells may need to be installed Free product is not recovered Buried infrastructure can interfere with the effectiveness of steam injection Off-gas treatment would be required | \$80,600 | \$23,740 | 82 | \$521,418 |
| E. Plume Stabilization Sheet Piling/Well Installation and Sampling Interceptor Trench | Contains the source | Only provides containment Heavy construction required Further remediation would be needed to recover residual oil | \$122,820 | \$2,500 | 100 | \$230,320 |
| F. Enhanced Biological Degradation Enhanced biodegradation (EBC) | Inexpensive installation costs Easy installation Increases the rate of natural attenuation | Applicable at sites with minimal amount of residual free product Special permits may be required to add material to the groundwater Biodegradation would mostly occur along the distal portions of the plume Free product is not recovered Long time period to achieve clean-up goals | \$310,243 \$433,063 | \$2,500 | 100 | \$540,563 |

* Annual operating costs include labor (maintenance/repairs) and electricity

Assumptions include the following:
\$0.075/kWh
\$70/hour labor
5% capital cost in maintenance per year
kinematic oil viscosity = 23 to 421 cSt at 10C
initial = 2%
Product recovery rates for each active system are assumed to be equal to the recovery rate of the formation.
At the present, approximately 60,000 gallons of product are available with 80% or 48,000 gallons recoverable.
The cost benefit of injecting recovered oil has not been included (\$36/bbl or approximately \$41,000 total).

FIGURES

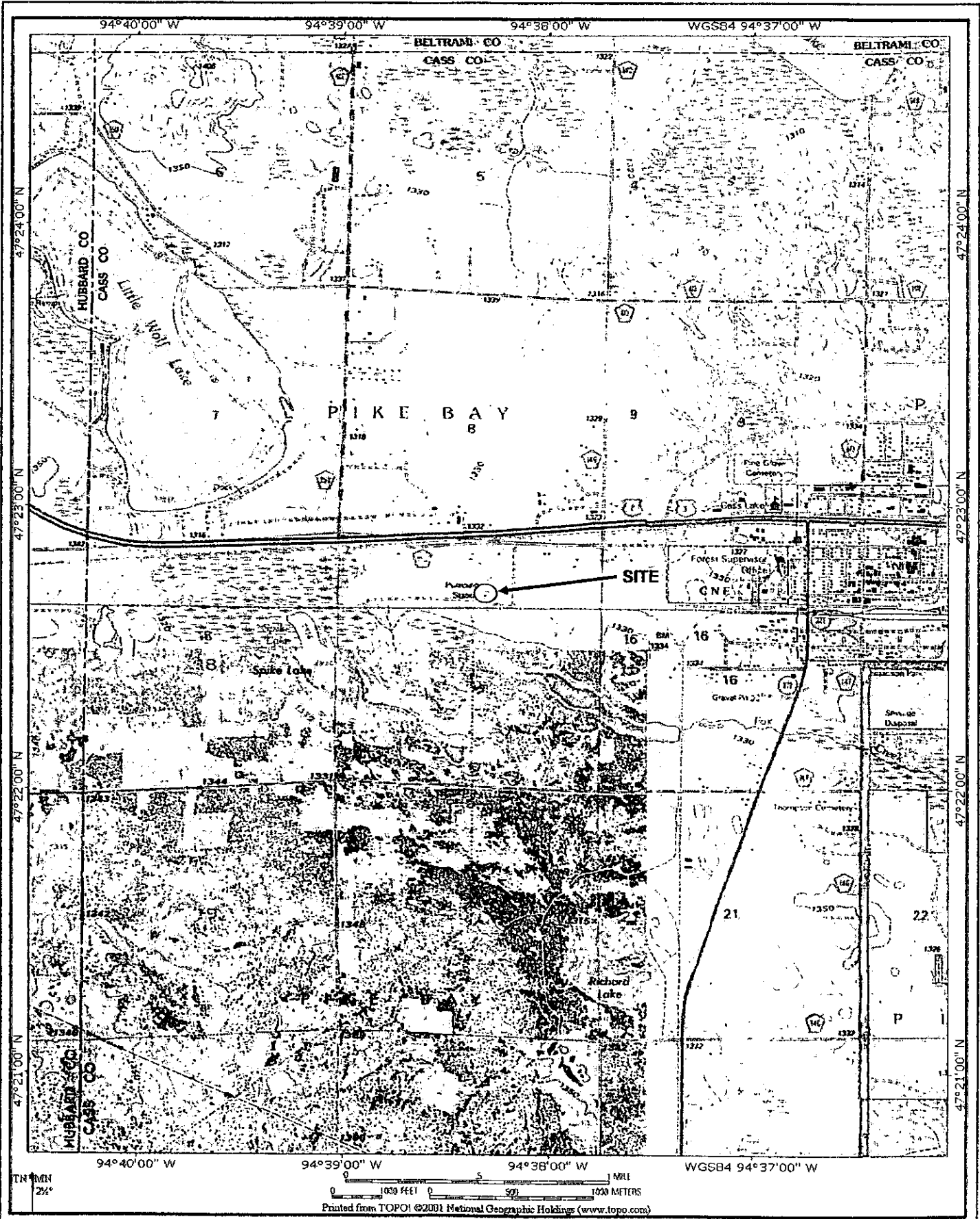

Site Location Map
South Cass Lake Station

Enbridge Pipelines (Lakehead), L.L.C.
119 N 25th St. East, Superior, WI 54880

Apr-04
Figure 1

ENBRIDGE PUMPING STATION

CASS LAKE, MINNESOTA

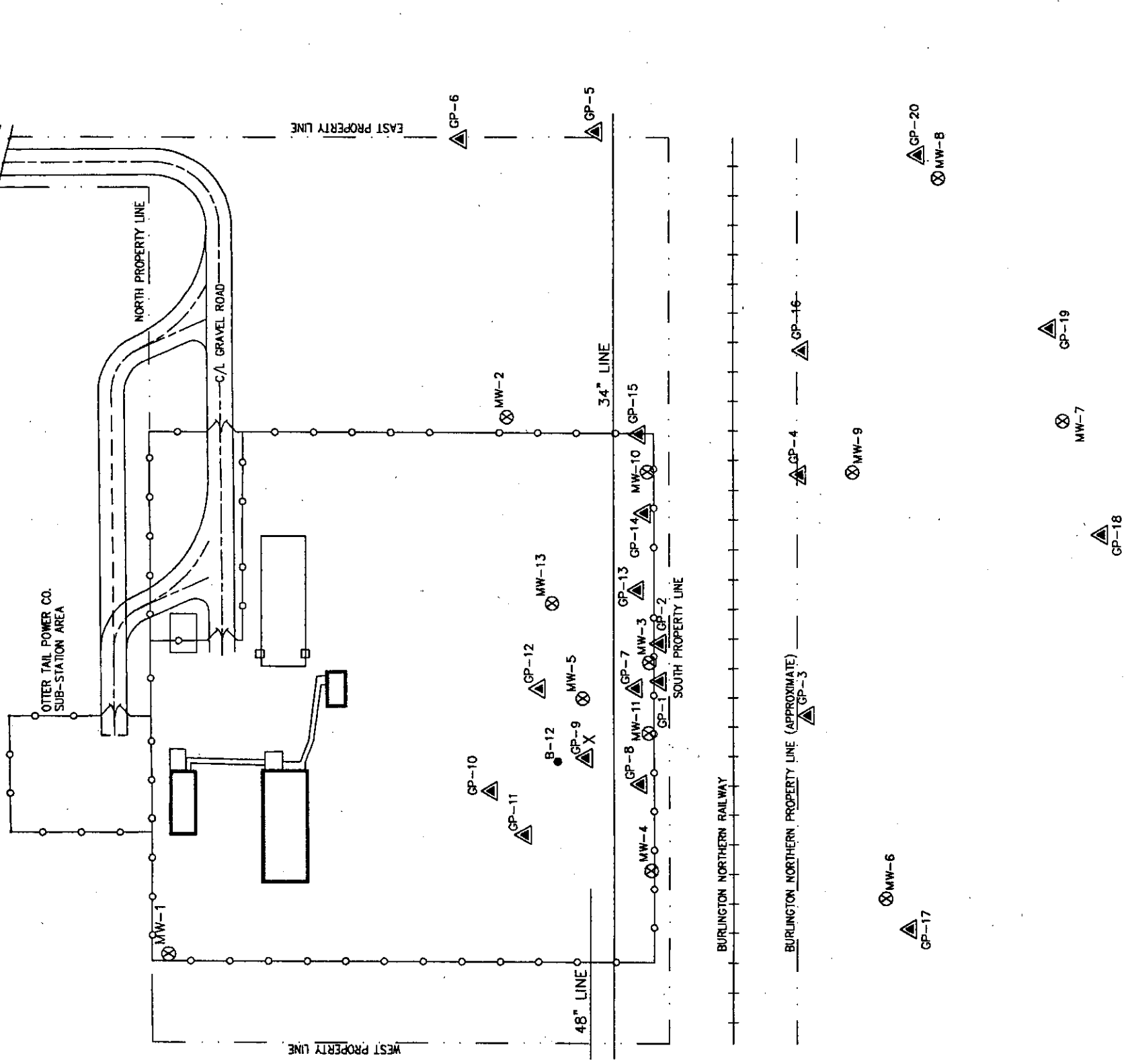

LEGEND

- ▲ PUSH PROBE BORING
- ⊗ MONITORING WELL
- X WEeping FLANGE
- DRILL BORING

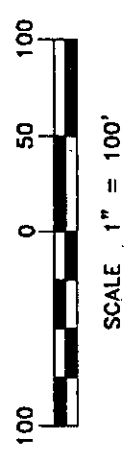

Natural Resources Engineering Company
DULUTH, MINNESOTA 55802

SITE LAY-OUT MAP
ENBRIDGE PUMPING STATION
CASS LAKE, MN

| | | | | |
|----------|-------|----------|---------------|-------------|
| DATE | DRAWN | APPROVED | LHB PROJ. NO. | DRAWING NO. |
| MAY 2002 | HEB | DAH | 01807.67 | FIGURE 2 |

ENBRIDGE PUMPING STATION

CASS LAKE, MINNESOTA

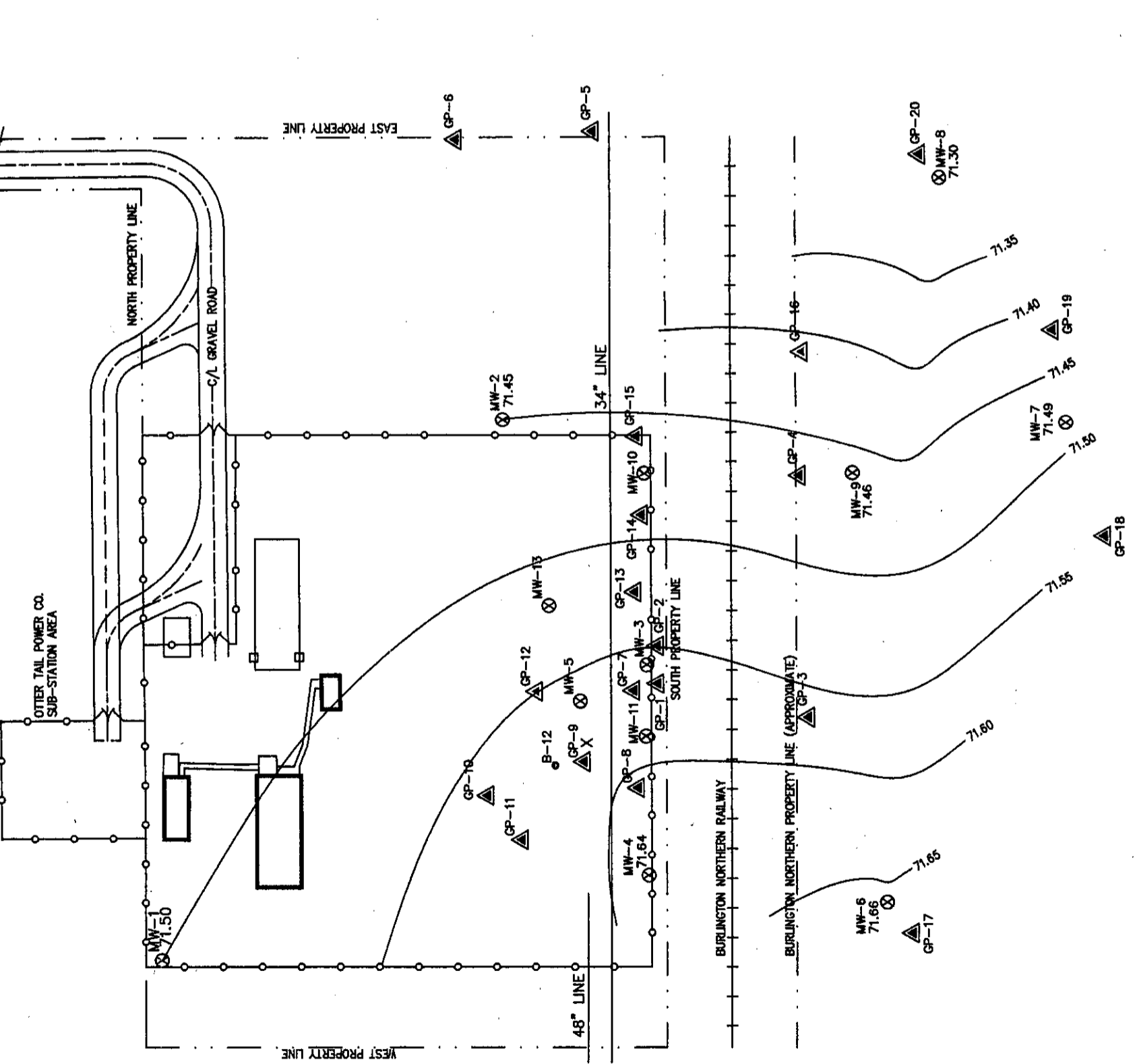

LEGEND

- ▲ PUSH PROBE BORING
- ⊗ MONITORING WELL
- X WEEPING FLANGE
- DRILL BORING

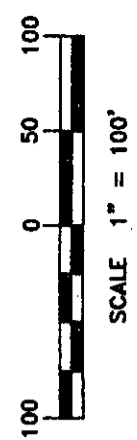

Natural Resources Engineering Company
DALLAS, MINNESOTA 55002

JANUARY 2004
GROUNDWATER FLOW REGIME
ENBRIDGE PUMPING STATION
CASS LAKE, MN

| | | | |
|--------|-------|----------|-------------|
| DATE | DRAWN | APPROVED | DRAWING NO. |
| 4-2004 | CCT | SH | FIGURE 3 |

ENBRIDGE PUMPING STATION

CASS LAKE, MINNESOTA

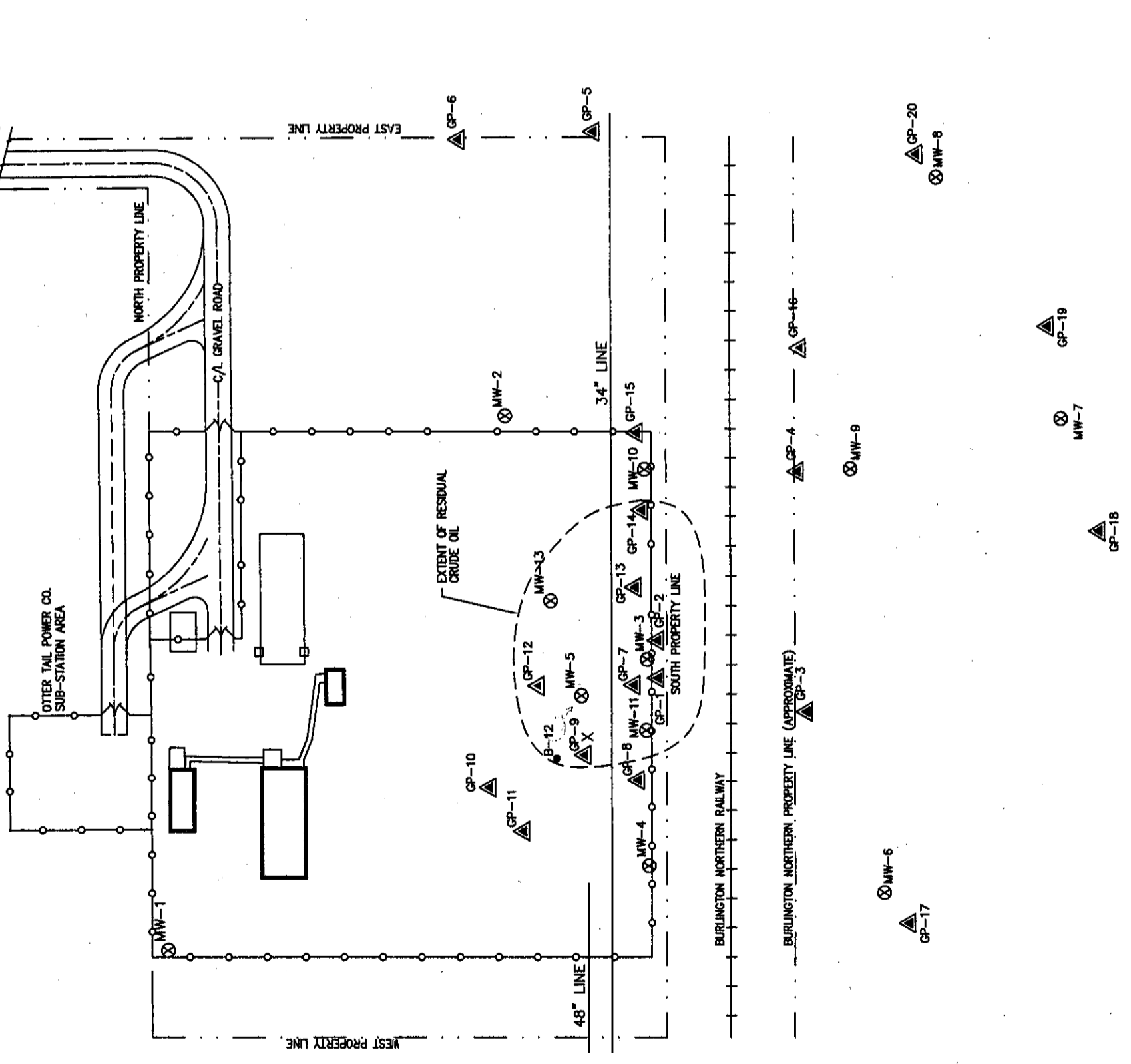

LEGEND

- ▲ PUSH PROBE BORING
- ⊗ MONITORING WELL
- X WEEPING FLANGE
- DRILL BORING

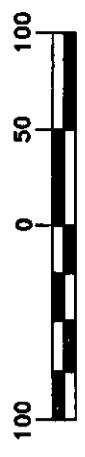

Natural Resources Engineering Company
DULUTH, MINNESOTA 55802

LATERAL EXTENT OF INFERRED SMEAR ZONE ENBRIDGE PUMPING STATION CASS LAKE, MN

| | | | |
|--------|-------|----------|-------------|
| DATE | DRAWN | APPROVED | DRAWING NO. |
| 4-2004 | CCT | BH | FIGURE 4 |

ENBRIDGE PUMPING STATION

CASS LAKE, MINNESOTA

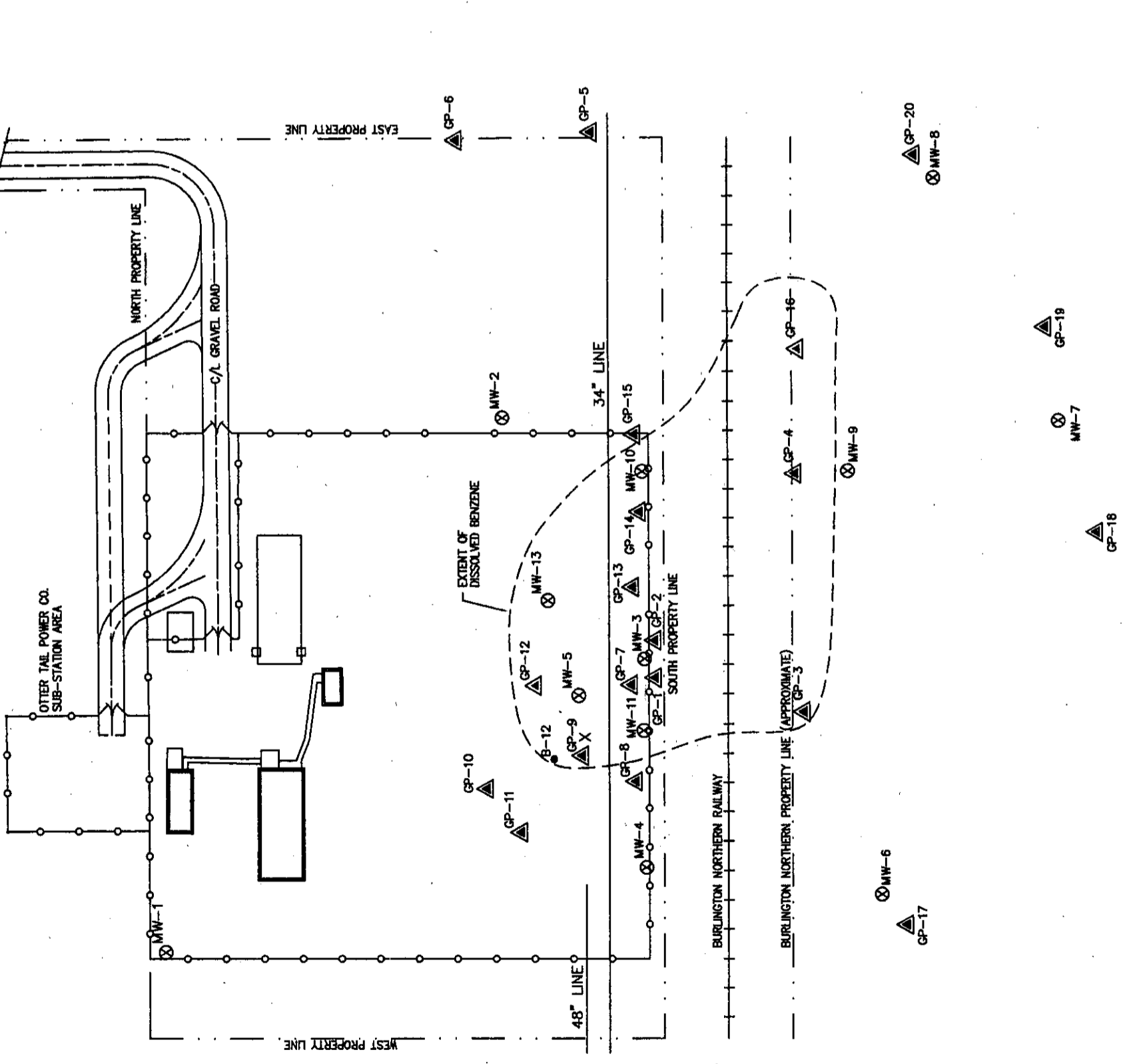

LEGEND

- ▲ PUSH PROBE BORING
- ⊗ MONITORING WELL
- X WEEPING FLANGE
- DRILL BORING

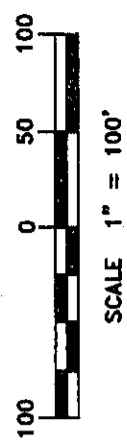

Natural Resources Engineering Company
 DULUTH, MINNESOTA 55802

LATERAL EXTENT OF DISSOLVED BENZENE IN THE GROUNDWATER ENBRIDGE PUMPING STATION CASS LAKE, MN

| | | | |
|--------|-------|----------|-------------|
| DATE | DRAWN | APPROVED | DRAWING NO. |
| 4-2004 | CCT | EH | FIGURE 5 |

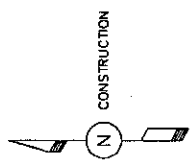

| NO. | REVISION | BY | DATE | APPR. |
|-----|----------|----|------|-------|
| | | | | |
| | | | | |
| | | | | |
| | | | | |

ENBRIDGE
Enbridge Energy,
Limited Partnership

CASS LAKE (MN) STATION

EXTENT OF ON SITE
RESIDUAL CRUDE OIL

PROJECT: FIELD SURVEY DATE: 4-29-04 DRAWN: CCT
SCALE: 1" = 40' APPR: DATE:
CHECK: APPR: DATE:
APPR:
APPR:

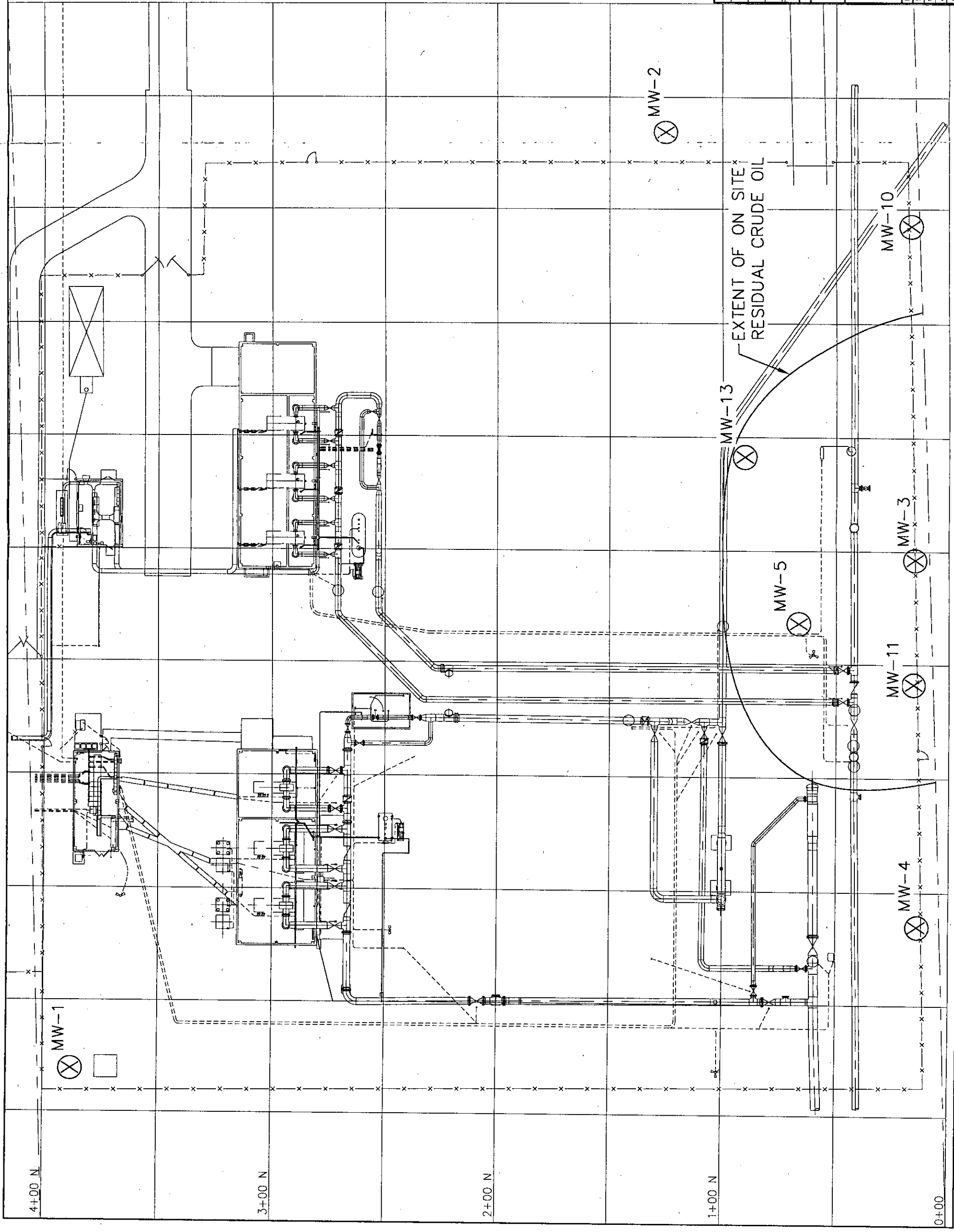

0+00

1+00 N

2+00 N

3+00 N

4+00 N

FIGURE 6

APPENDICES

**APPENDIX A –
WELL CONSTRUCTION AND BORING LOGS**

Monitoring Well Construction Information

WELL DESIGNATION MW-5

PROJECT EEC - South Cass Lake

DRILLER Thein Well Company

COMPLETION DATE 12/17/2003

Elev.(± 0.01') _____

(Grade Elevation)

CONCRETE SURFACE SEAL:

Y/N Y

Elev.(± 0.01') _____

(Top of Inner Casing w/o Cover)

OUTER CASING:

Type Carbon Steel
 Diameter 4 inches
 Total Length 5 feet
 Lock Yes

State Plane N 651974.3570
Coord.: E 2243693.9200

Method of Advance:
 Hollow Stem Auger

INNER CASING:

Type PVC
 Diameter 2-inch
 Total Length 21 feet
 Sections Used 3
 Joints 2

Borehole Diameter: 8 inches

Drilling Fluid: None

GROUT ABOVE SEAL:
 Neat Cement Grout

**Depth to Bottom
of Grout :** 17 feet

SEALING MATERIAL:
 Bentonite Chips

**Depth to Bottom
of Seal :** 19 feet

FILTER MATERIAL:
 # 30 Red Flint Sand

**Depth to top of
Screen :** 21 feet

SCREEN:
 Type PVC
 Length 10 feet
 Diameter 2-inch
 Slot Size 0.01-inch

**Depth to Bottom
of Boring :** 31 feet

PUMP:
 Type N/A
 Length N/A
 Diameter N/A

**Depth to First
Water Encountered
during Drilling :** _____

**Note: All depths are from
Ground Level

**Depth to Water Level
before Installation :** _____

METHOD OF DEVELOPMENT: Surge with weighted bailer and bailed.

CONSTRUCTION NOTES: _____

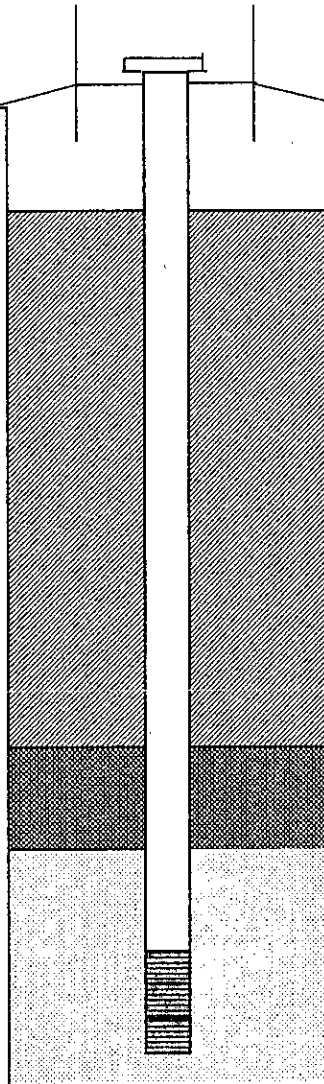

Monitoring Well Construction Information

WELL DESIGNATION: MW-10

PROJECT: EEC - South Cass Lake

DRILLER: Thein Well Company

COMPLETION DATE: 12/16/2003

Elev. ($\pm 0.01'$) _____

(Grade Elevation)

CONCRETE SURFACE SEAL:

Y/N Y

Elev. ($\pm 0.01'$) _____

(Top of Inner Casing w/o Cover)

OUTER CASING:

Type Carbon Steel
Diameter 4 inches
Total Length 5 feet
Lock Yes

State Plane N 651932.6480

Coord.: E 2243852.6260

INNER CASING:

Type PVC
Diameter 2-inch
Total Length 20 feet
Sections Used 3
Joints 2

Method of Advance: _____

Hollow Stem Auger

Borehole Diameter: 8 inches

Drilling Fluid: None

GROUT ABOVE SEAL:
Neat Cement Grout

Depth to Bottom of Grout: 16 feet

SEALING MATERIAL:
Bentonite Chips

Depth to Bottom of Seal: 18 feet

FILTER MATERIAL:
30 Red Flint Sand

Depth to top of Screen: 20 feet

SCREEN:
Type PVC
Length 10 feet
Diameter 2-inch
Slot Size 0.01-inch

Depth to Bottom of Boring: 30 feet

PUMP:
Type N/A
Length N/A
Diameter N/A

Depth to First Water Encountered during Drilling: _____

****Note: All depths are from Ground Level**

Depth to Water Level before Installation: _____

METHOD OF DEVELOPMENT: Surge with weighted bailer and bailed.

CONSTRUCTION NOTES: _____

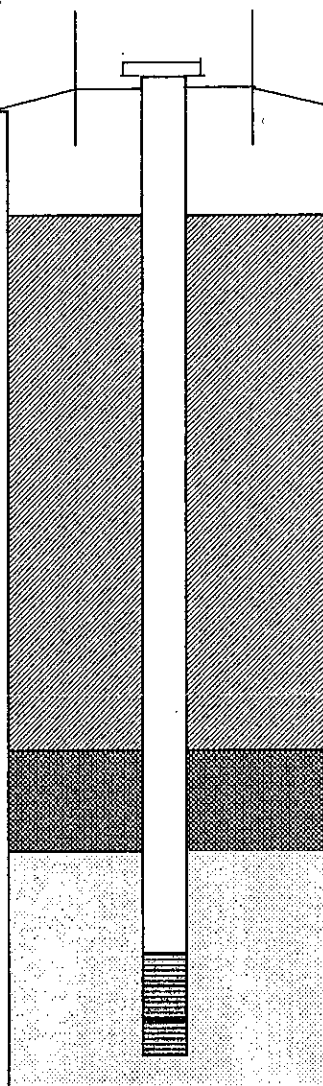

Monitoring Well Construction Information

WELL DESIGNATION MW-11 PROJECT EEC - South Cass Lake

DRILLER Thein Well Company COMPLETION DATE 12/16/2003

Elev.(± 0.01') _____
 (Grade Elevation) Y/N Y

Elev.(± 0.01') _____
 (Top of Inner Casing w/o Cover) OUTER CASING:

State Plane N 651938.5230
 Coord.: E 2243658.4770
 Lock Yes

Method of Advance: Hollow Stem Auger
 INNER CASING:

Borehole Diameter: 8 inches
 Drilling Fluid: None
 Type Carbon Steel
 Diameter 4 inches
 Total Length 5 feet
 Lock Yes

Depth to Bottom of Grout : 17 feet
 GROUT ABOVE SEAL: Neat Cement Grout

Depth to Bottom of Seal : 19 feet
 SEALING MATERIAL: Bentonite Chips

Depth to top of Screen : 21 feet
 FILTER MATERIAL: # 30 Red Flint Sand

Depth to Bottom of Boring : 31 feet
 SCREEN:

Depth to First Water Encountered during Drilling : _____
 Depth to Water Level before Installation : _____
 Type PVC
 Length 10 feet
 Diameter 2-inch
 Slot Size 0.01-inch
 PUMP:

Type N/A
 Length N/A
 Diameter N/A

METHOD OF DEVELOPMENT: Surge with weighted bailer and bailed.

CONSTRUCTION NOTES: _____

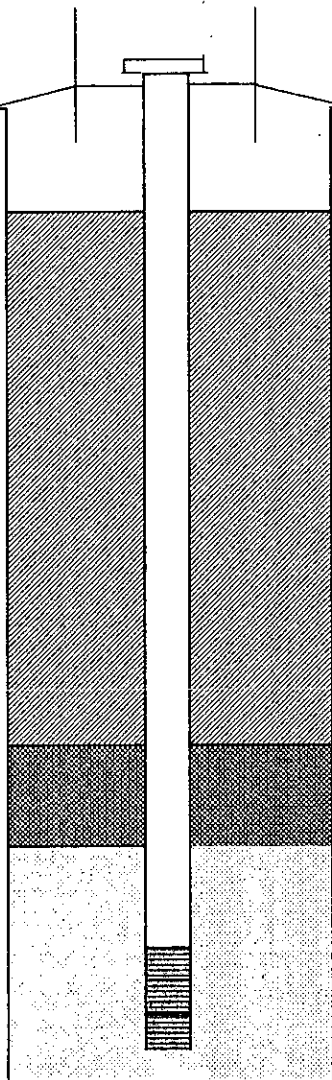

Monitoring Well Construction Information

WELL DESIGNATION MW-13

PROJECT EEC - South Cass Lake

DRILLER Thein Well Company

COMPLETION DATE 12/18/2003

Elev.(± 0.01') _____

(Grade Elevation)

Elev.(± 0.01') _____

(Top of Inner Casing w/o Cover)

State Plane Coord.: N 652003.9910
E 2243743.3980

Method of Advance:
Hollow Stem Auger

Borehole Diameter: 8 inches

Drilling Fluid: None

Depth to Bottom of Grout : 20 feet

Depth to Bottom of Seal : 22 feet

Depth to top of Screen : 24 feet

Depth to Bottom of Boring : 34 feet

Depth to First Water Encountered during Drilling : _____

Depth to Water Level before Installation : _____

CONCRETE SURFACE SEAL:
Y/N Y

OUTER CASING:
Type Carbon Steel
Diameter 4 inches
Total Length 5 feet
Lock Yes

INNER CASING:
Type PVC
Diameter 2-inch
Total Length 24 feet
Sections Used 3
Joints 2

GROUT ABOVE SEAL:
Neat Cement Grout

SEALING MATERIAL:
Bentonite Chips

FILTER MATERIAL:
30 Red Flint Sand

SCREEN:
Type PVC
Length 10 feet
Diameter 2-inch
Slot Size 0.01-inch

PUMP:
Type N/A
Length N/A
Diameter N/A



**Note: All depths are from Ground Level

METHOD OF DEVELOPMENT: Surge with weighted bailer and bailed.

CONSTRUCTION NOTES: _____

NATURAL RESOURCES ENGINEERING COMPANY

69 N 28th Street Suite 27, Superior, WI 54880

BORING LOG NO: **MW-5**

PROJECT NAME: EEC Detection Monitoring

PROJ. NO.

PROJECT LOCATION: South Cass Lake Station, MN

CHECKED BY: **BDH**

SUBSURFACE PROFILE

SOIL SAMPLE DATA

| Interval (feet) | USCS | Description | Depth (Ft.) | OVM (ppm) | Analytical Sample Analysis | Blows/6" |
|-----------------|----------------------------|--|-------------|-----------|----------------------------|---------------|
| 1 to 5 | SP SP SP SP SP | Brown, medium-grained sand. | | < 5 | None Collected | None Recorded |
| 5 to 10 | SP SP | Same SP as above. | | < 5 | | |
| 10 to 15 | SP SP | Same SP as above. | | < 5 | | |
| 15 to 20 | SP SP | Same SP as above. Petro odor at 18'. | | 56.7 | | |
| 20 to 23 | SP | Same SP as above. | | 24.3 | | |
| 24 | SP | Brown, coarse sand. | | 193 | | |
| 25 | SP | Wet at 25 feet. | ▼ | 110 | | |
| 26 | SP | | | 134 | | |
| 27 | SP | Brown, coarse sand with occasional gravel. | | 64.7 | | |
| 28 | SP | Same wet SP as above | | | | |
| 29 | SP | Tan, silty sand with gravel to 31'. | | | | |
| 30 | SP | | | | | |
| 31 | SP | EOB at 31 feet. | | | | |

TOTAL DEPTH: 31 feet
 DRILLING DATE: 12/17/2003
 INSPECTOR: BDH
 CONTRACTOR: Thein Well Company

DRILLING METHOD: Hollow Stem Auger
 WATER LEVEL OBSERVATION: 25 feet

NATURAL RESOURCES ENGINEERING COMPANY

69 N 28th Street Suite 27, Superior, WI 54880

BORING LOG NO: **MW-10**

PROJECT NAME: EEC Detection Monitoring

PROJ. NO.

PROJECT LOCATION: South Cass Lake Station, MN

CHECKED BY: **BDH**

| SUBSURFACE PROFILE | | | | SOIL SAMPLE DATA | | |
|--------------------|----------------------------|--|-------------|------------------|----------------------------|---------------|
| Interval (feet) | USCS | Description | Depth (Ft.) | OVM (ppm) | Analytical Sample Analysis | Blows/6" |
| 1 to 5 | SP SP SP SP SP | Brown, medium-grained sand. | | < 5 | None collected | None Recorded |
| 5 to 10 | SP SP | Same SP as above. | | < 5 | | |
| 10 to 15 | SP SP | Same SP as above. | | < 5 | | |
| 15 to 20 | SP SP | Same SP as above. | | <5 | | |
| 20 to 23 | SP | Same SP as above. | | <5 | | |
| 24 | SP | Brown, coarse sand. Wet at 24 feet. | ▼ | 127 | | |
| 25 | SP | Oil stained at 24 feet for 3". | | 393 | | |
| 26 | SP | Brown, coarse sand with occasional gravel. | | | | |
| 27 | SP | | | | | |
| 28 | SP | Same as above. | | 251 | | |
| 29 | SP | | | | | |
| 30 | SP | EOB at 30 feet. | | 26.5 | | |

| | | | |
|----------------|--------------------|--------------------------|-------------------|
| TOTAL DEPTH: | 30 feet | DRILLING METHOD: | Hollow Stem Auger |
| DRILLING DATE: | 12/17/2003 | WATER LEVEL OBSERVATION: | 24 feet |
| INSPECTOR: | BDH | | |
| CONTRACTOR: | Thein Well Company | | |

NATURAL RESOURCES ENGINEERING COMPANY

69 N 28th Street Suite 27, Superior, WI 54880

BORING LOG NO: **MW-11**

PROJECT NAME: EEC Detection Monitoring

PROJ. NO.

PROJECT LOCATION: South Cass Lake Station, MN

CHECKED BY: BDH

| SUBSURFACE PROFILE | | | | SOIL SAMPLE DATA | | |
|--------------------|----------------------------|--|-------------|------------------|----------------------------|---------------|
| Interval (feet) | USCS | Description | Depth (Ft.) | OVM (ppm) | Analytical Sample Analysis | Blows/6" |
| 1 to 5 | SP SP SP SP SP | Brown, medium-grained sand. | | < 5 | None Collected | None Recorded |
| 5 to 10 | SP SP | Same SP as above. | | < 5 | | |
| 10 to 15 | SP SP | Same SP as above. | | < 5 | | |
| 15 to 20 | SP SP | Same SP as above. | | < 5 | | |
| 20 to 23 | SP | Same SP as above. | | < 5 | | |
| 24 | SP | Brown, coarse sand. | | | | |
| 25 | SP | Wet at 25 feet. Oil stained at 25' for 6". | ▼ | 383 | | |
| 26 | SP | | | 506 | | |
| 27 | SP | Brown, coarse sand with occasional gravel. | | | | |
| 28 | SP | Same wet SP as above | | 216 | | |
| 29 | SP | Tan, silty sand with gravel to 31'. | | | | |
| 30 | SP | | | 54.1 | | |
| 31 | SP | EOB at 31 feet. | | | | |

TOTAL DEPTH: 31 feet
 DRILLING DATE: 12/17/2003
 INSPECTOR: BDH
 CONTRACTOR: Thein Well Company

DRILLING METHOD: Hollow Stem Auger
 WATER LEVEL OBSERVATION: 25 feet

NATURAL RESOURCES ENGINEERING COMPANY

69 N 28th Street Suite 27, Superior, WI 54880

BORING LOG NO: **MW-13**

PROJECT NAME: EEC Detection Monitoring

PROJ. NO.

PROJECT LOCATION: South Cass Lake Station, MN

CHECKED BY: **BDH**

| SUBSURFACE PROFILE | | | | SOIL SAMPLE DATA | | |
|--------------------|----------------------------|--|-------------|------------------|----------------------------|---------------|
| Interval (feet) | USCS | Description | Depth (Ft.) | OVM (ppm) | Analytical Sample Analysis | Blows/6" |
| 1 to 5 | SP SP SP SP SP | Brown, medium-grained sand. | | < 5 | None collected | None Recorded |
| 5 to 10 | SP SP | Same SP as above. | | < 5 | | |
| 10 to 15 | SP SP | Same SP as above. | | < 5 | | |
| 15 to 20 | SP SP | Same SP as above. | | <5 | | |
| 20 to 23 | SP | Same SP as above. | | <5 | | |
| 24 | SP | Same SP as above. | | 533 | | |
| 25 | SP | Faint petro odor at 24 feet. | | | | |
| 26 | SP | Brown, coarse sand with occasional gravel. | | | | |
| 27 | SP | | ▼ | 55.5 | | |
| 28 | SP | | | | | |
| 29 | SP | | | | | |
| 30 | SP | Same SP as above. | | | | |
| 31 | SP | Tan, silty sand with clay to 34'. | | 18.1 | | |
| 32 | SP | | | | | |
| 33 | SP | | | 7.1 | | |
| 34 | SP | EOB at 34 feet. | | | | |

TOTAL DEPTH: 34 feet

DRILLING METHOD: Hollow Stem Auger

DRILLING DATE: 12/17/2003

INSPECTOR: BDH

WATER LEVEL OBSERVATION: 28 feet

CONTRACTOR: Thein Well Company

NATURAL RESOURCES ENGINEERING COMPANY

69 N 28th Street Suite 27, Superior, WI 54880

BORING LOG NO: **B-12**

PROJECT NAME: EEC Detection Monitoring

PROJ. NO.

PROJECT LOCATION: South Cass Lake Station, MN

CHECKED BY: **BDH**

| SUBSURFACE PROFILE | | | | SOIL SAMPLE DATA | | |
|--------------------|----------------------------|--|-------------|------------------|----------------------------|---------------|
| Interval (feet) | USCS | Description | Depth (Ft.) | OVM (ppm) | Analytical Sample Analysis | Blows/6" |
| 1 to 5 | SP SP SP SP SP | Brown, medium-grained sand. | | < 5 | None collected | None Recorded |
| 5 to 10 | SP SP | Same SP as above. | | < 5 | | |
| 10 to 15 | SP SP | Same SP as above. | | < 5 | | |
| 15 to 20 | SP SP | Same SP as above. | | <5 | | |
| 20 to 23 | SP | Brown coarse grained sand. | | <5 | | |
| 24 | SP | Same SP as above. | | | | |
| 25 | SP | Faint petro odor at 24 feet. Oil stained @ 24.5' for 6". | ▼ | 79.3 | | |
| 26 | SP | Brown, coarse sand with occasional gravel. | | 583 | | |
| 27 | SP | | | | | |
| 28 | SP | | | 728 | | |
| 29 | SP | | | | | |
| 30 | SP | Tan, silty sand with gravel to 34'. EOB @31'. | | 285 | | |
| 31 | SP | EOB @ 31'. | | | | |

TOTAL DEPTH: 31 feet
 DRILLING DATE: 12/17/2003
 INSPECTOR: BDH
 CONTRACTOR: Thein Well Company

DRILLING METHOD: Hollow Stem Auger
 WATER LEVEL OBSERVATION: 25 feet

WELL LOCATION
County Name
CASS

MINNESOTA DEPARTMENT OF HEALTH
WELL AND BORING RECORD
Minnesota Statutes, Chapter 103I

MINNESOTA UNIQUE WELL NO.
705515

Township Name: **145** Township No.: **31** Range No.: **17** Section No.: **SW NW NE** Fraction: **31**

WELL DEPTH (completed) **31** ft. Date Work Completed **12-17-03**

GPS LOCATION: Latitude _____ degrees _____ minutes _____ seconds _____
Longitude _____ degrees _____ minutes _____ seconds _____

DRILLING METHOD
 Cable Tool Driven Dug
 Auger Rotary Jetted

House Number, Street Name, City, and Zip Code of Well Location
CR 151 & MN HWY 371 CASS LAKE

DRILLING FLUID: **NONE USED** WELL HYDROFRACTURED? Yes No
FROM _____ ft. TO _____ ft.

Show exact location of well in section grid with "X". Sketch map of well location. Showing property lines, roads and buildings

USE
 Domestic Monitoring Heating/Cooling
 Noncommunity PWS Environ. Bore Hole Industry/Commercial
 Community PWS Irrigation Remedial
 Dewatering

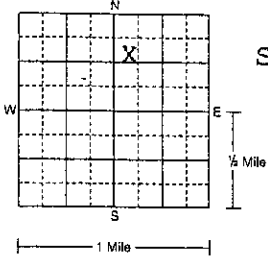

SEE ATTACHED MAP

CASING Drive Shoe? Yes No
 Steel Threaded Welded
 Plastic

PROPERTY OWNER'S NAME/COMPANY NAME
ENBRIDGE ENERGY

CASING DIAMETER: **2** in. to **21** ft. WEIGHT: _____ lbs./ft. **8 1/4** in. to _____ ft.
_____ in. to _____ ft. _____ lbs./ft. _____ in. to _____ ft.
_____ in. to _____ ft. _____ lbs./ft. _____ in. to _____ ft.

Property owner's mailing address if different than well location address indicated above.
**119 N 25TH STREET
SUPERIOR WI 54880**

SCREEN Make **JOHNSON** OPEN HOLE FROM _____ ft. TO _____ ft.
Type **PVC** Diam. **2"**
Slot/Gauze **10 SLOT** Length **10'**
Set between **21** ft. and **31** ft. FITTINGS _____

WELL OWNER'S NAME/COMPANY NAME
SAME AS ABOVE

STATIC WATER LEVEL **25** ft. below above land surface Date measured **12-17-03**

Well owner's mailing address if different than property owners address indicated above.

PUMPING LEVEL (below land surface) **N/A** ft. after _____ hrs. pumping _____ g.p.m.

WELL HEAD COMPLETION
 Pitless adapter manufacturer _____ Model _____
 Casing Protection **6" PRO-TOP** 12 in. above grade
 At-grade (Environmental Wells and Boring ONLY)

| GEOLOGICAL MATERIALS | COLOR | HARDNESS OF MATERIAL | FROM | TO |
|-----------------------|--------|----------------------|------|----|
| COARSE SAND | BRN/GR | MED | 0 | 23 |
| COARSE SAND | GR | MED | 23 | 25 |
| ROCKY GRAVELY SAND | GR/BLK | HARD | 25 | 27 |
| COARSE SAND GRAVEL | GR/BLK | M/H | 27 | 29 |
| SAND/SILTY SANDY CLAY | GR | H/M | 29 | 31 |

GROUTING INFORMATION
Well grouted Yes No
Grout material Neat cement Bentonite Concrete High Solids Bentonite
from **0** to **4** ft. **2** yds. bags
from **4** to **16** ft. **1** yds. bags
from **16** to **18** ft. **1** yds. bags

NEAREST KNOWN SOURCE OF CONTAMINATION **UNKNOWN** feet _____ direction _____ type _____
Well disinfected upon completion Yes No

PUMP Not installed Date installed _____
Manufacturer's name _____
Model number _____ HP _____ Volts _____
Length of drop pipe _____ ft. Capacity _____ g.p.m.
Type: Submersible L.S. Turbine Reciprocating Jet _____

ABANDONED WELLS
Does property have any not in use and not sealed well(s) Yes No

VARIANCE
Was a variance granted from the MDH for this well? Yes No TN# _____

WELL CONTRACTOR CERTIFICATION
This well was drilled under my supervision and in accordance with Minnesota Rules, Chapter 4725. The information contained in this report is true to the best of my knowledge.

REMARKS, ELEVATION, SOURCE OF DATA, etc.
MW#5
NRE

THEIN WELL 34625
Licensee Business Name _____ Lic. or Reg. No. _____
Nathan Herrboldt 12-30-03
Authorized Representative Signature _____ Date _____

IMPORTANT - FILE WITH PROPERTY PAPERS
WELL OWNER COPY **705515**

NATHAN HERRBOLDT
Name of Driller
HE-01205-08 (Rev. 5/02)

MINNESOTA DEPARTMENT OF HEALTH
WELL AND BORING RECORD
 Minnesota Statutes, Chapter 103I

MINNESOTA UNIQUE WELL NO.

705513

WELL LOCATION
 County Name
CASS
 Township Name
 Township No. **145** Range No. **31** Section No. **17** Fraction **SW NW NE**

WELL DEPTH (completed) **30.5** ft. Date Work Completed **12-16-03**

GPS LOCATION: Latitude _____ degrees _____ minutes _____ seconds _____
 Longitude _____ degrees _____ minutes _____ seconds _____

DRILLING METHOD
 Cable Tool Driven Dug
 Auger Rotary Jetted

House Number, Street Name, City, and Zip Code of Well Location or Fire Number

CR 151 & MN HWY 371 CASS LAKE

DRILLING FLUID **NONE USED** WELL HYDROFRACTURED? Yes No
 FROM _____ ft. TO _____ ft.

Show exact location of well in section grid with "X". Sketch map of well location. Showing property lines, roads and buildings

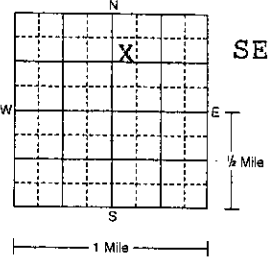

SEE ATTACHED MAP

USE
 Domestic Monitoring Heating/Cooling
 Noncommunity PWS Environ. Bore Hole Industry/Commercial
 Community PWS Irrigation Remedial
 Dewatering

PROPERTY OWNER'S NAME/COMPANY NAME
ENBRIDGE ENERGY

CASING Drive Shoe? Yes No
 Steel Threaded Welded
 Plastic

Property owner's mailing address if different than well location address indicated above.
**119 N 25TH STREET
 SUPERIOR WI 54880**

CASING DIAMETER **2** in. to **20.5** ft. WEIGHT _____ lbs./ft. **8 1/2** in. to _____ ft.
 _____ in. to _____ ft. _____ lbs./ft. _____ in. to _____ ft.
 _____ in. to _____ ft. _____ lbs./ft. _____ in. to _____ ft.

WELL OWNER'S NAME/COMPANY NAME
SAME AS ABOVE

SCREEN Make **JOHNSON** OPEN HOLE FROM _____ ft. TO _____ ft.
 Type **PVC** Diam. **2"**
 Slot/Gauze **10 SLOT** Length **10'**
 Set between **20.5** ft. and **30.5** ft. FITTINGS _____

Well owner's mailing address if different than property owners address indicated above.

STATIC WATER LEVEL **24.5** ft. below above land surface Date measured **12-16-03**

| GEOLOGICAL MATERIALS | COLOR | HARDNESS OF MATERIAL | FROM | TO |
|------------------------|--------|----------------------|------|----|
| COARSE SAND | BRN | MED | 0 | 23 |
| COARSE SAND | BRN | MED | 23 | 25 |
| COARSE SAND | BRN | MED | 25 | 27 |
| COARSE TO GRAVELY SAND | BRN/GR | MED | 29 | 31 |
| | | | | |
| | | | | |
| | | | | |
| | | | | |

PUMPING LEVEL (below land surface) _____ ft. after _____ hrs. pumping _____ g.p.m.

WELL HEAD COMPLETION
 Pitless adapter manufacturer _____ Model _____
 Casing Protection **6" PRO-TOP** 12 in. above grade
 At-grade (Environmental Wells and Boring ONLY)

GROUTING INFORMATION
 Well grouted Yes No
 Grout material Neat cement Bentonite Concrete High Solids Bentonite
 from **0** to **4** ft. **2** yds. bags
 from **4** to **15.5** ft. **1** yds. bags
 from **15.5** to **17.5** ft. **1** yds. bags

NEAREST KNOWN SOURCE OF CONTAMINATION
UNKNOWN feet _____ direction _____ type _____

Well disinfected upon completion Yes No

PUMP Not installed Date installed _____

Manufacturer's name _____
 Model number _____ HP _____ Volts _____

Length of drop pipe _____ ft. Capacity _____ g.p.m.
 Type: Submersible L.S. Turbine Reciprocating Jet

ABANDONED WELLS
 Does property have any not in use and not sealed well(s) Yes No

VARIANCE
 Was a variance granted from the MDH for this well? Yes No TN# _____

WELL CONTRACTOR CERTIFICATION
 This well was drilled under my supervision and in accordance with Minnesota Rules, Chapter 4725. The information contained in this report is true to the best of my knowledge.

REMARKS, ELEVATION, SOURCE OF DATA, etc.
MW#10
NRE

THEIN WELL **34625**
 Licensee Business Name _____ Lic. or Reg. No. _____

Nathan Herrboldt **12-30-03**
 Authorized Representative Signature _____ Date _____

NATHAN HERRBOLDT
 Name of Driller _____

IMPORTANT - FILE WITH PROPERTY PAPERS
 WELL OWNER COPY **705513**

MINNESOTA DEPARTMENT OF HEALTH
WELL AND BORING RECORD
 Minnesota Statutes, Chapter 103I

MINNESOTA UNIQUE WELL NO.

705514

WELL LOCATION
 County Name
CASS
 Township Name
145 Township No. **31** Range No. **17** Section No. **SW NW NE** Fraction

WELL DEPTH (completed) **31** ft. Date Work Completed **12-16-03**

GPS LOCATION: Latitude _____ degrees _____ minutes _____ seconds _____
 Longitude _____ degrees _____ minutes _____ seconds _____

DRILLING METHOD
 Cable Tool Driven Dug
 Auger Rotary Jetted

House Number, Street Name, City, and Zip Code of Well Location or Fire Number

CR 151 & MN HWY 371 CASS LAKE
 Show exact location of well in section grid with "X".

DRILLING FLUID **NONE USED** WELL HYDROFRACTURED? Yes No
 FROM _____ ft. TO _____ ft.

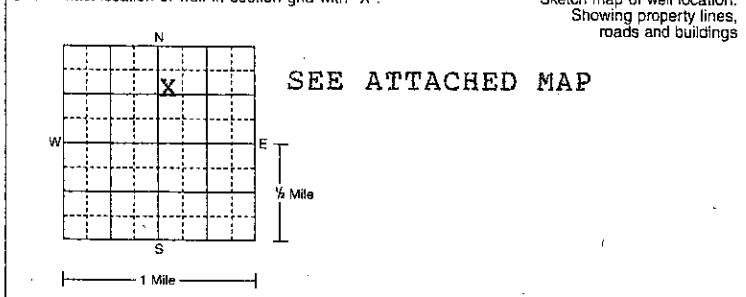

USE
 Domestic Monitoring Heating/Cooling
 Noncommunity PWS Environ. Bore Hole Industry/Commercial
 Community PWS Irrigation Remediat
 Dewatering

PROPERTY OWNER'S NAME/COMPANY NAME

ENBRIDGE ENERGY
 Property owner's mailing address if different than well location address indicated above.
**119 N 25TH STREET
 SUPERIOR WI 54880**

CASING Drive Shoe? Yes No
 Steel Threaded Welded
 Plastic

CASING DIAMETER WEIGHT
2 in. to **21** ft. _____ lbs./ft. **8 1/2** in. to _____ ft.
 _____ in. to _____ ft. _____ lbs./ft. _____ in. to _____ ft.
 _____ in. to _____ ft. _____ lbs./ft. _____ in. to _____ ft.

WELL OWNER'S NAME/COMPANY NAME

SAME AS ABOVE
 Well owner's mailing address if different than property owners address indicated above.

SCREEN OPEN HOLE
 Make **JOHNSON** FROM _____ ft. TO _____ ft.
 Type **PVC** Diam. **2"**
 Slot/Gauze **10 SLOT** Length **10'**
 Set between **21** ft. and **31** ft. FITTINGS

STATIC WATER LEVEL
25 ft. below above land surface Date measured **12-16-03**

PUMPING LEVEL (below land surface)
N/A ft. after _____ hrs. pumping _____ g.p.m.

WELL HEAD COMPLETION
 Pitless adapter manufacturer _____ Model _____
 Casing Protection **6" PRO-TOP** 12 in. above grade
 At-grade (Environmental Wells and Boring ONLY)

GROUTING INFORMATION
 Well grouted Yes No
 Grout material Neat cement Bentonite Concrete High Solids Bentonite
 from **0** to **4** ft. **2** _____ yds. bags
 from **4** to **16** ft. **1** _____ yds. bags
 from **16** to **18** ft. **1** _____ yds. bags

| GEOLOGICAL MATERIALS | COLOR | HARDNESS OF MATERIAL | FROM | TO |
|--------------------------------|--------|----------------------|------|----|
| COARSE SAND | BRN | MED | 0 | 23 |
| COARSE SAND W/GRAVEL GR/BLK M | | | 23 | 25 |
| ROCKS GRAVELY SAND BLK/GR | | MED | 25 | 27 |
| GRAVELY SAND | BLK/GR | M/H | 27 | 29 |
| GRAVELY SAND/SANDY CLAY GR/BRN | | | 29 | 31 |
| | | MED/HARD | | |

NEAREST KNOWN SOURCE OF CONTAMINATION
UNKNOWN feet _____ direction _____ type _____
 Well disinfected upon completion Yes No

PUMP
 Not installed Date installed _____
 Manufacturer's name _____
 Model number _____ HP _____ Volts _____
 Length of drop pipe _____ ft. Capacity _____ g.p.m.
 Type: Submersible L.S. Turbine Reciprocating Jet

ABANDONED WELLS
 Does property have any not in use and not sealed well(s) Yes No

VARIANCE
 Was a variance granted from the MDH for this well? Yes No TN# _____

WELL CONTRACTOR CERTIFICATION
 This well was drilled under my supervision and in accordance with Minnesota Rules, Chapter 4725. The information contained in this report is true to the best of my knowledge.

REMARKS, ELEVATION, SOURCE OF DATA, etc.
MW#11
 Use a second sheet, if needed

THEIN WELL 34625
 Licensee, Business Name _____ Lic. or Reg. No. _____

12-30-03
 Authorized Representative Signature _____ Date _____

IMPORTANT - FILE WITH PROPERTY PAPERS
 WELL OWNER COPY **705514**

NATHAN HERRBOLDT
 Name of Driller

WELL LOCATION

County Name

cass

Township No. **145** Range No. **31** Section No. **17** Fraction **SW NW NE**

GPS LOCATION: Latitude _____ degrees _____ minutes _____ seconds _____
Longitude _____ degrees _____ minutes _____ seconds _____

House Number, Street Name, City, and Zip Code of Well Location or Fire Number

CR 151 & MN HWY 371 CASS LAKE

Show exact location of well in section grid with "X".

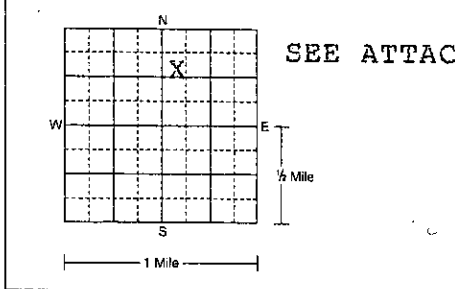

PROPERTY OWNER'S NAME/COMPANY NAME

ENBRIDGE ENERGY

Property owner's mailing address if different than well location address indicated above.

**119 N 25TH STREET
SUPERIOR WI 54880**

WELL OWNER'S NAME/COMPANY NAME

SAME AS ABOVE

Well owner's mailing address if different than property owners address indicated above.

| GEOLOGICAL MATERIALS | COLOR | HARDNESS OF MATERIAL | FROM | TO |
|--------------------------------|--------|----------------------|------|----|
| COARSE SAND | BRN | MED | 0 | 23 |
| SAND | GR/BRN | MED | 23 | 28 |
| WET SAND | GR | MED | 28 | 30 |
| SAND GRAVEL/SANDY GRAVELY CLAY | | | | |
| | GR/BRN | MED | 30 | 32 |
| SANDY GRAVELY CLAY | BRN | MED | 32 | 34 |

REMARKS, ELEVATION, SOURCE OF DATA, etc.

MW#13

NRE

IMPORTANT - FILE WITH PROPERTY PAPERS
WELL OWNER COPY

MINNESOTA DEPARTMENT OF HEALTH
WELL AND BORING RECORD
Minnesota Statutes, Chapter 103I

MINNESOTA UNIQUE WELL NO.

705516

WELL DEPTH (completed) **34** ft. Date Work Completed **12-18-03**

DRILLING METHOD
 Cable Tool
 Auger
 Driven
 Rotary
 Dug
 Jetted

DRILLING FLUID **NONE USED** WELL HYDROFRACTURED? Yes No
FROM _____ ft. TO _____ ft.

USE
 Domestic
 Noncommunity PWS
 Community PWS
 Monitoring
 Environ. Bore Hole
 Irrigation
 Dewatering
 Heating/Cooling
 Industry/Commercial
 Remedial

CASING Drive Shoe? Yes No
 Steel
 Plastic
 Threaded
 Welded

CASING DIAMETER **2** in. to **24** ft. _____ lbs./ft. **8 1/2** in. to _____ ft.
 _____ in. to _____ ft. _____ lbs./ft. _____ in. to _____ ft.
 _____ in. to _____ ft. _____ lbs./ft. _____ in. to _____ ft.

SCREEN OPEN HOLE
 Make **JOHNSON** FROM _____ ft. TO _____ ft.
 Type **PVC** Diam. **2"**

Slot/Gauze **10 SLOT** Length **10'**
 Set between **24** ft. and **34** ft. FITTINGS

STATIC WATER LEVEL
27.5' ft. below above land surface Date measured **12-18-03**

PUMPING LEVEL (below land surface)
N/A ft. after _____ hrs. pumping g.p.m.

WELL HEAD COMPLETION
 Piless adapter manufacturer _____ Model _____
 Casing Protection **6" PRO-TOP** 12 in. above grade
 At-grade (Environmental Wells and Boring ONLY)

GROUTING INFORMATION
 Well grouted Yes No
 Grout material Neat cement Bentonite Concrete High Solids Bentonite
 from **0** to **4** ft. **2** yds. bags
 from **4** to **19** ft. **1** yds. bags
 from **19** to **21** ft. **1** yds. bags

NEAREST KNOWN SOURCE OF CONTAMINATION
UNKNOWN feet _____ direction _____ type

Well disinfected upon completion Yes No

PUMP
 Not installed Date installed _____

Manufacturer's name _____
 Model number _____ HP _____ Volts

Length of drop pipe _____ ft. Capacity _____ g.p.m.
 Type: Submersible L.S. Turbine Reciprocating Jet

ABANDONED WELLS
 Does property have any not in use and not sealed well(s) Yes No

VARIANCE
 Was a variance granted from the MDH for this well? Yes No TN# _____

WELL CONTRACTOR CERTIFICATION
 This well was drilled under my supervision and in accordance with Minnesota Rules, Chapter 4725. The information contained in this report is true to the best of my knowledge.

THEIN WELL **34625**
 Licensee Business Name Lic. or Reg. No.

Nathan Herrboldt
 Authorized Representative Signature Date **12-30-03**

NATHAN HERRBOLDT
 Name of Driller

Use a second sheet, if needed

REMARKS, ELEVATION, SOURCE OF DATA, etc.

MW#13

NRE

IMPORTANT - FILE WITH PROPERTY PAPERS
WELL OWNER COPY

**APPENDIX B – HYDRAULIC CONDUCTIVITY AND VELOCITY
CALCULATIONS**

HYDRAULIC CONDUCTIVITY CALCULATIONS

Slug test data was analyzed using a Bouwer-Rice unconfined aquifer analysis. This method of analysis is valid for fully or partially penetrating wells in unconfined or confined aquifers (if screened sufficiently below the confining layer). It is a semi-empirical relationship based upon the conservation of mass. It incorporates empirical relationships between the well geometry and groundwater flow using electric analog models.

The method assumes that the aquifer is locally homogeneous and isotropic with respect to conductivity, the groundwater flow is laminar, and there is no resistance to flow in the vertical direction. It also assumes that the change in head due to the slug is much less than the saturated thickness of the aquifer. Hydraulic conductivity is calculated with the use of equation (1).

$$K = \frac{r_c^2 \ln\left(\frac{R_e}{r_w}\right)}{2L} \frac{1}{t} \ln\left(\frac{Y_o}{Y_t}\right) \quad (1)$$

Where:

| | | |
|----------------|---|---|
| K | = | mean hydraulic conductivity (l/t) |
| r _c | = | radius of casing (l) |
| r _w | = | radius of screened section plus gravel pack (l) |
| Y _o | = | static head (l) |
| Y _t | = | head at time t (l) |
| R _e | = | effective distance over which Y is dissipated (l) |
| L | = | length of screened section (l) |

The term $1/t \cdot \ln(Y_o/Y_t)$ in equation (1) is the slope of a line regressed on the straight portion of the data as plotted on semi-logarithmic paper. These plots can be found in this appendix.

From the data for recovery and dissipation, both a geometric mean and an arithmetic mean were calculated. These values were 32.1 ft/day and 55.9 ft/day, respectively. Table 2 is a summary of calculated hydraulic conductivities from the slug test data.

MW-5: Slug Dissipation
Enbridge Pipelines (Lakehead), L.L.C. - South Cass Lake Station

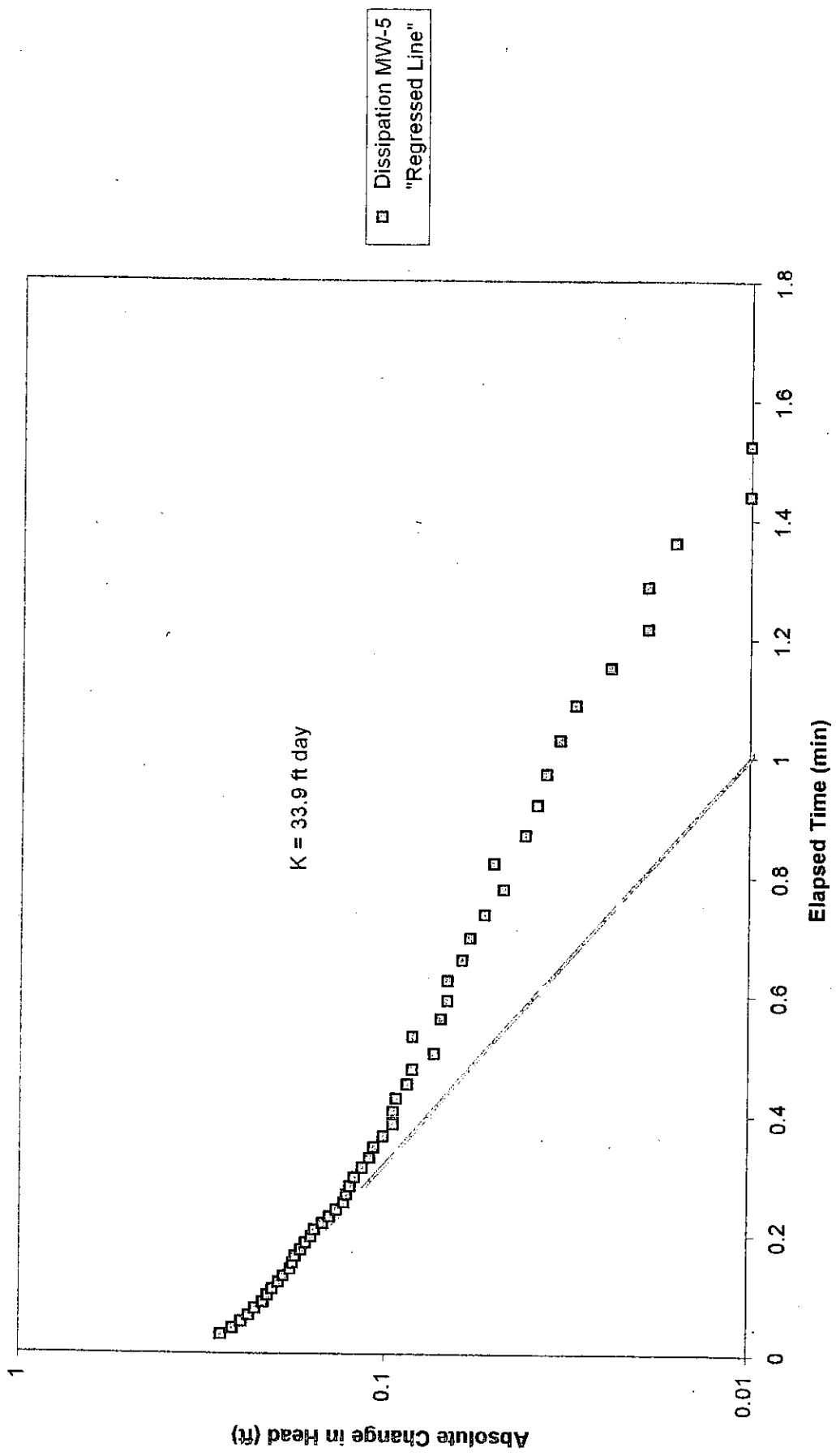

MW-5R: Slug Recovery
Enbridge Pipelines (Lakehead), L.L.C. - South Cass Lake Station

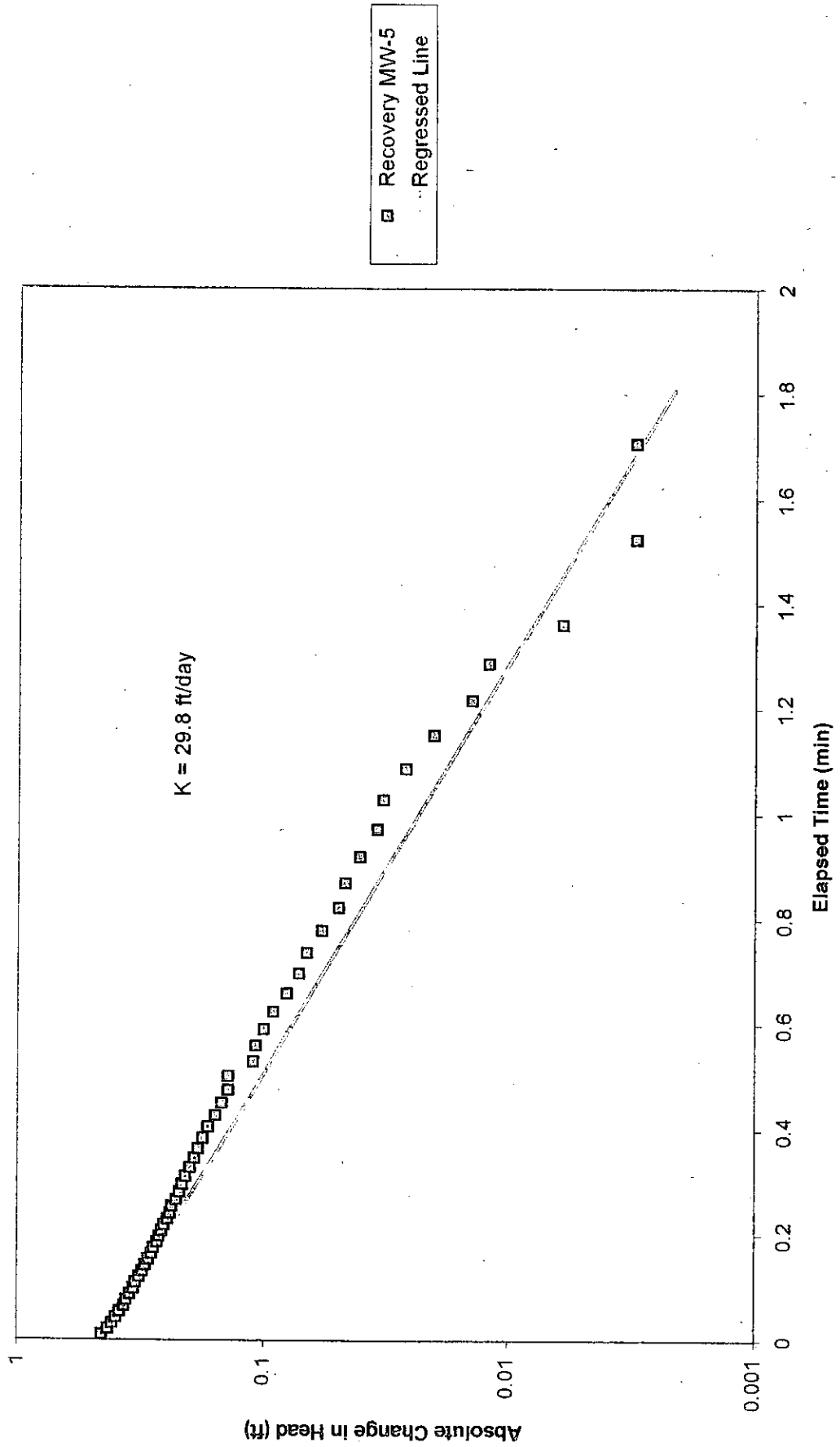

MW-10: Slug Recovery
Enbridge Pipelines (Lakehead), L.L.C. - South Cass Lake Station

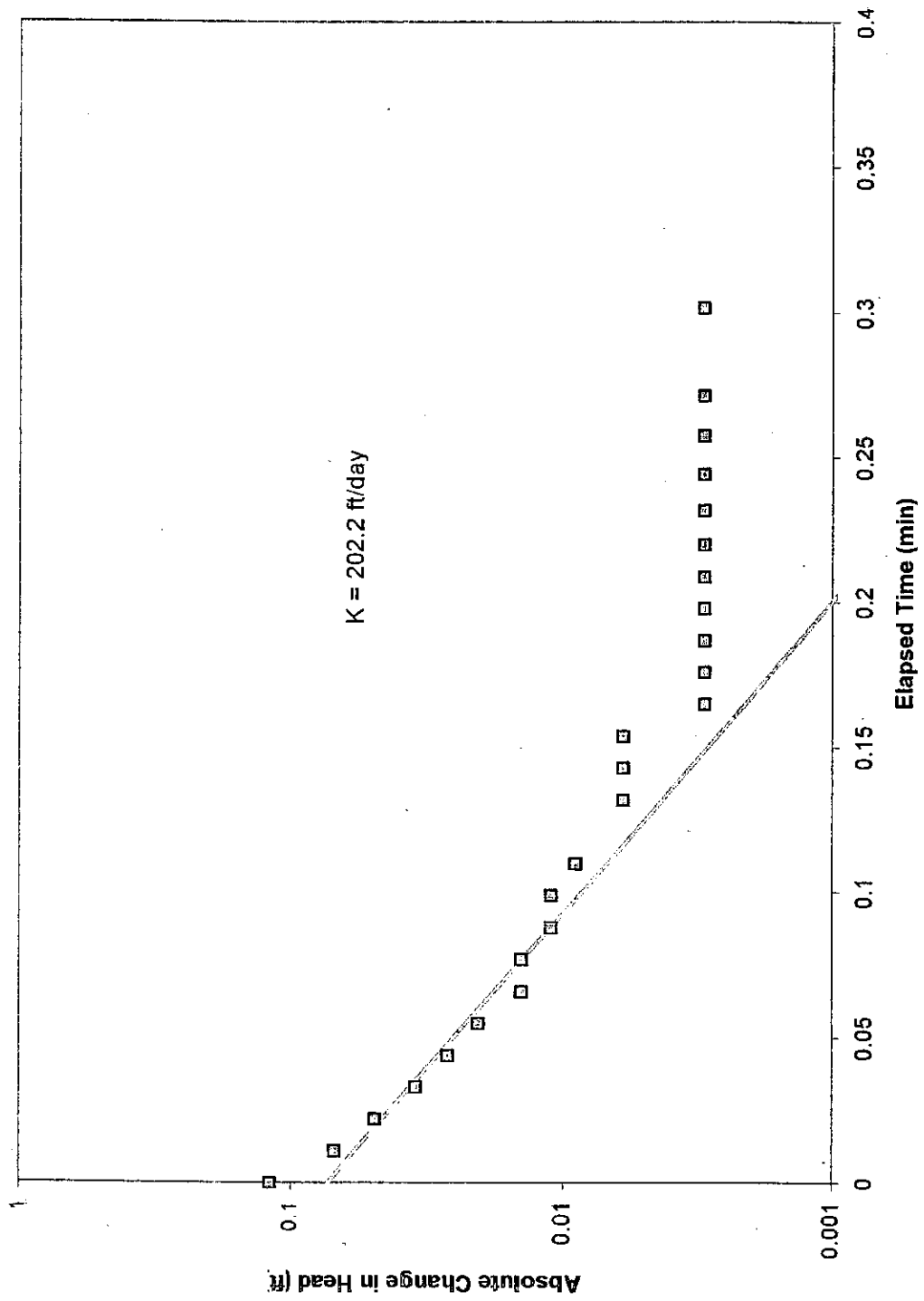

MW-10: Slug Dissipation
Enbridge Pipelines (Lakehead), L.L.C. - South Cass Lake Station

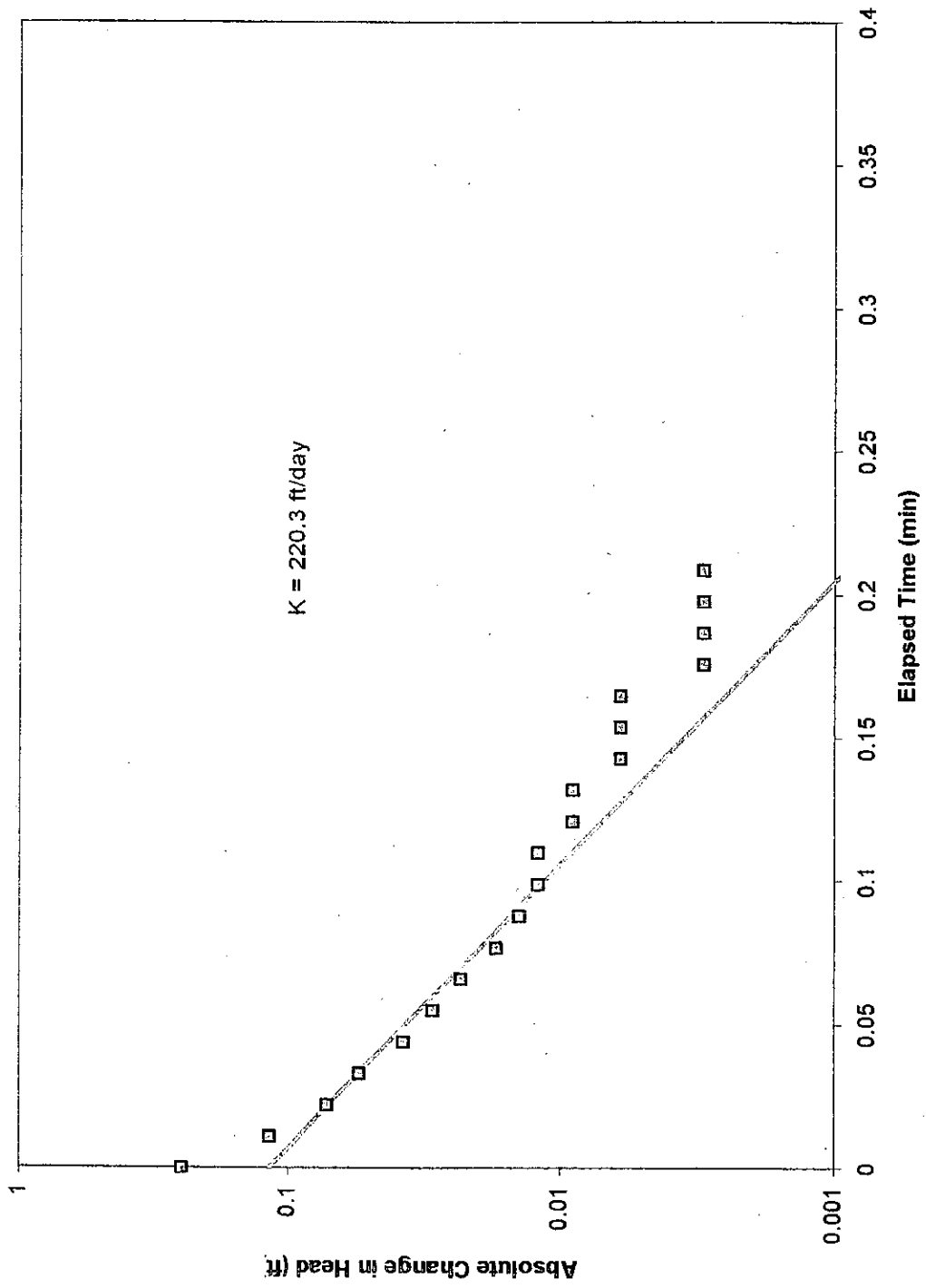

□ Dissipation MW-10
- Regressed Line

MW-11: Slug Dissipation
Enbridge Pipelines (Lakehead), L.L.C. - South Cass Lake Station

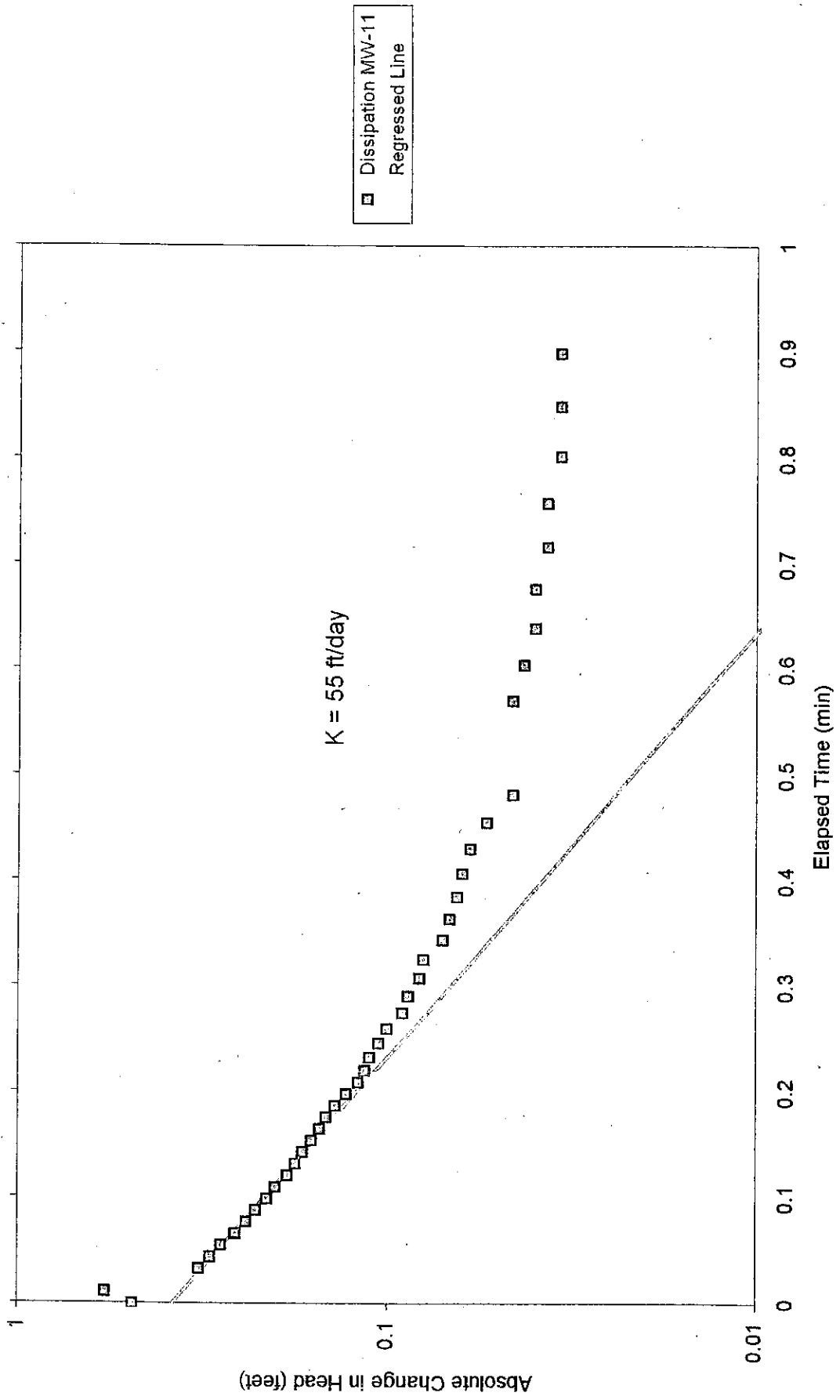

MW-11: Slug Recovery
Enbridge Pipelines (Lakehead), L.L.C. - South Cass Lake Station

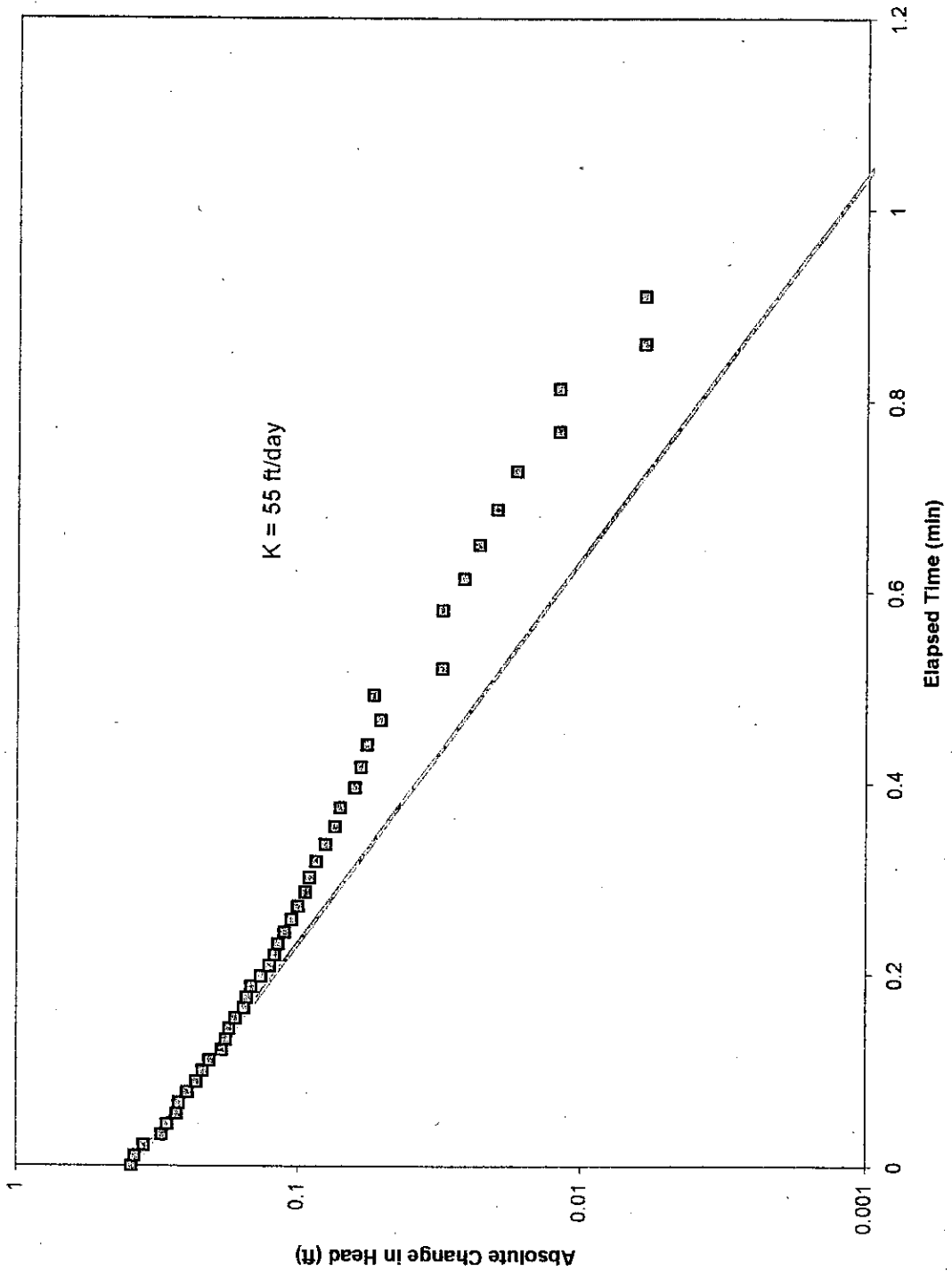

Recovery MW-11
Regressed Line

MW-13: Slug Dissipation
Enbridge Pipelines (Lakehead), L.L.C. - South Cass Lake Station

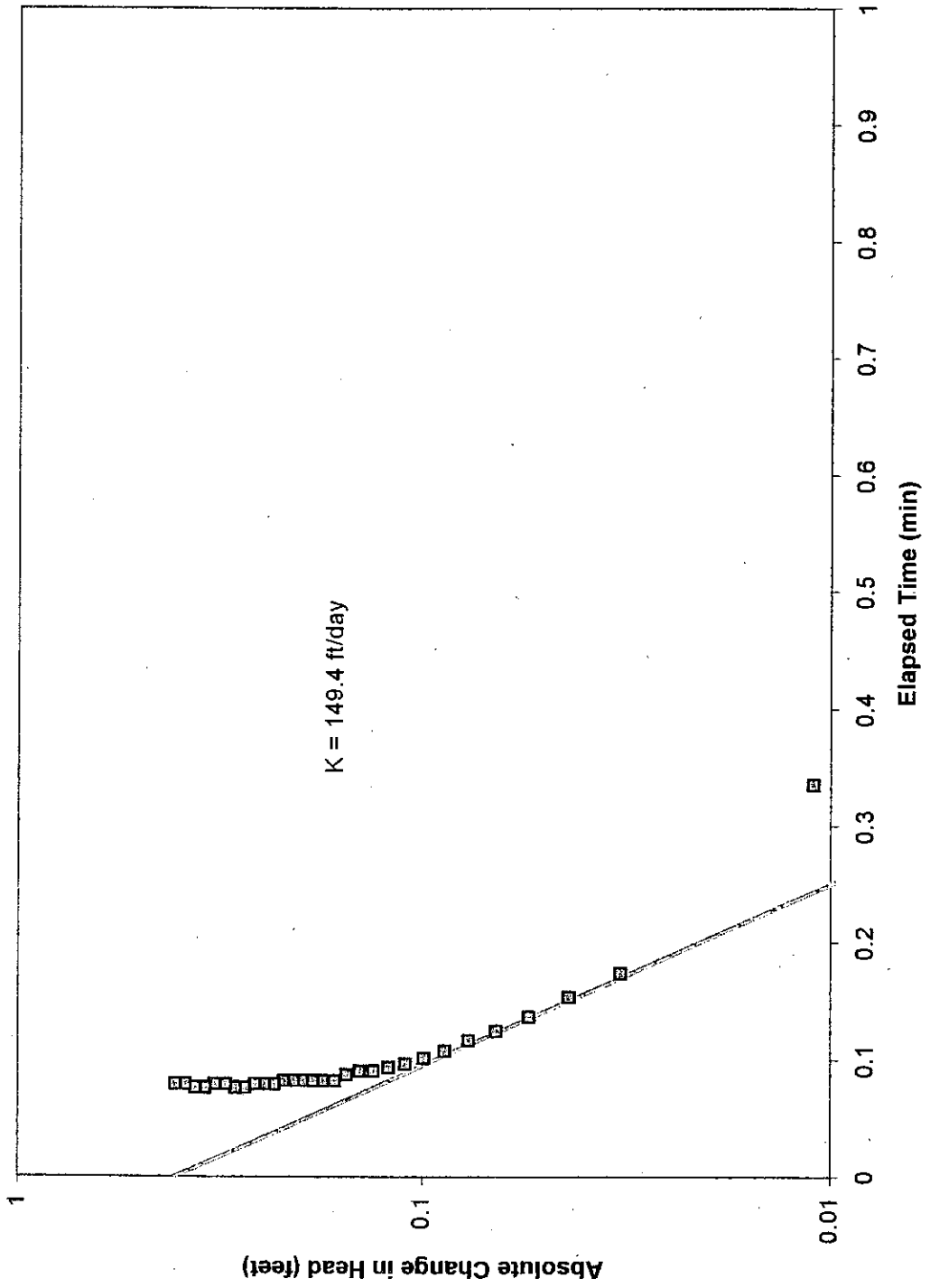

MW-13: Slug Recovery
Enbridge Pipelines (Lakehead), L.L.C. - South Cass Lake Station

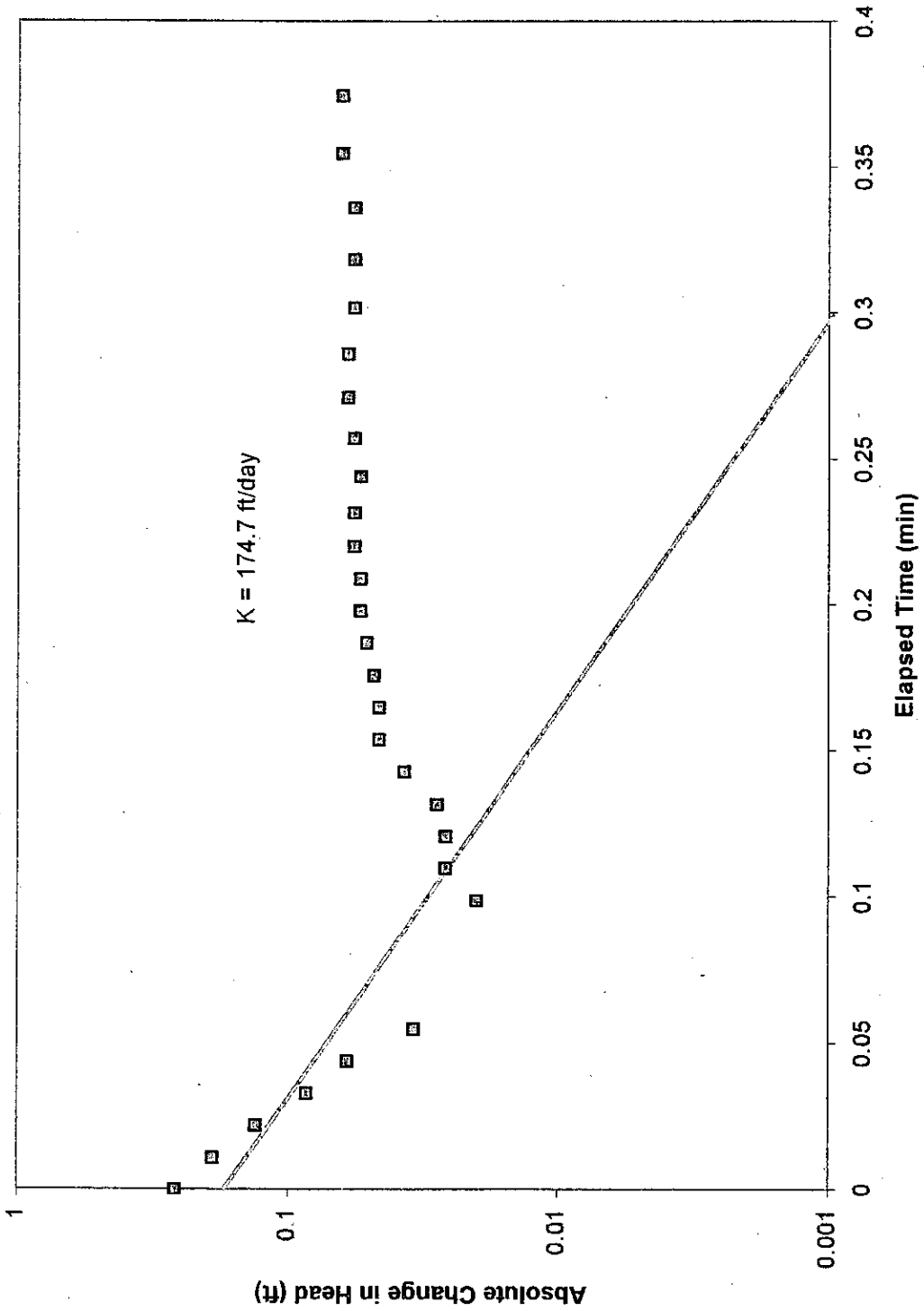

Hydraulic Conductivity, Log-Normal Distribution
 Enbridge Energy, L.L.C. -- South Cass Lake

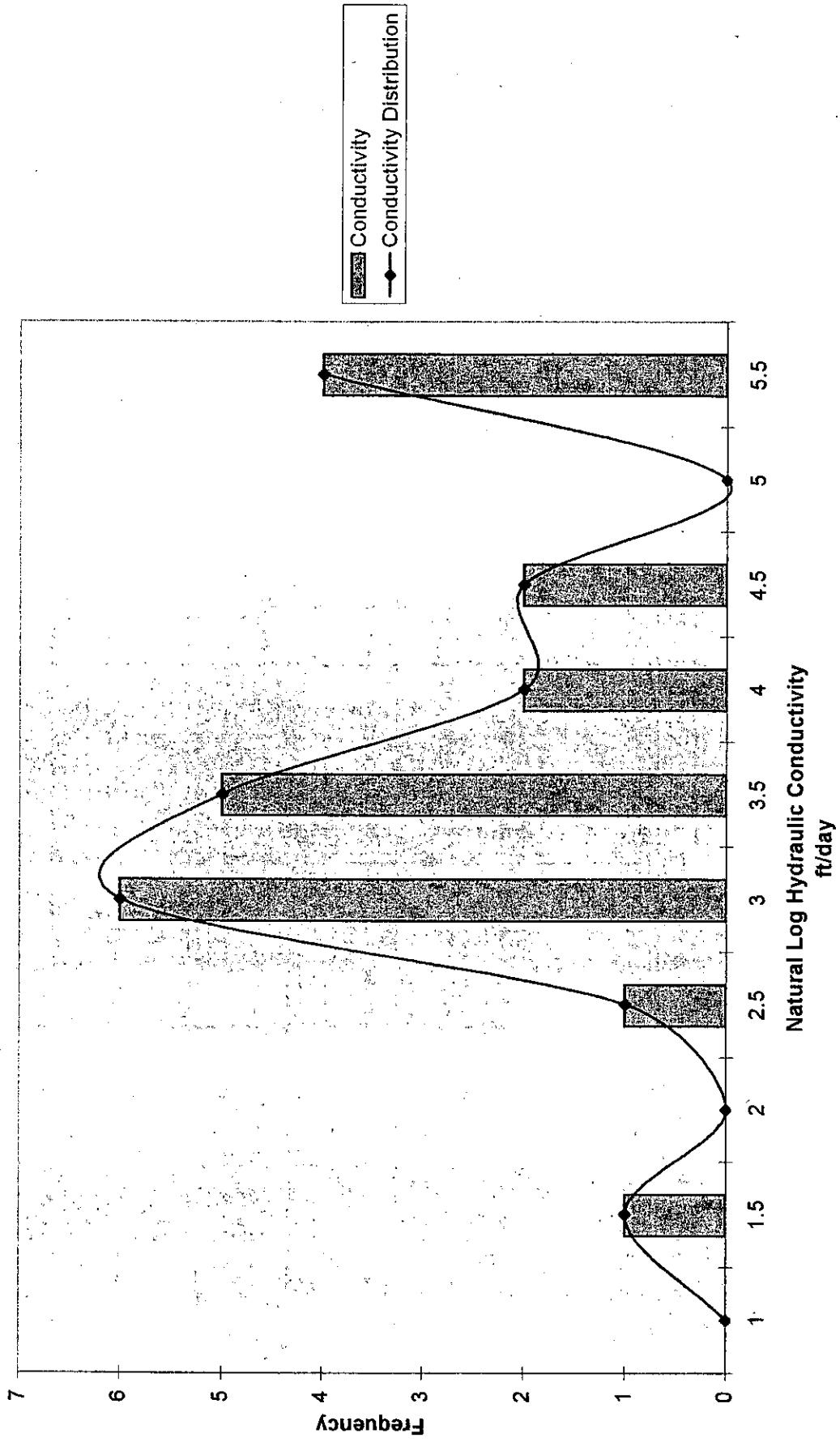

Hydraulic Conductivity, Normal Distribution
Enbridge Energy, L.L.C. -- South Cass Lake

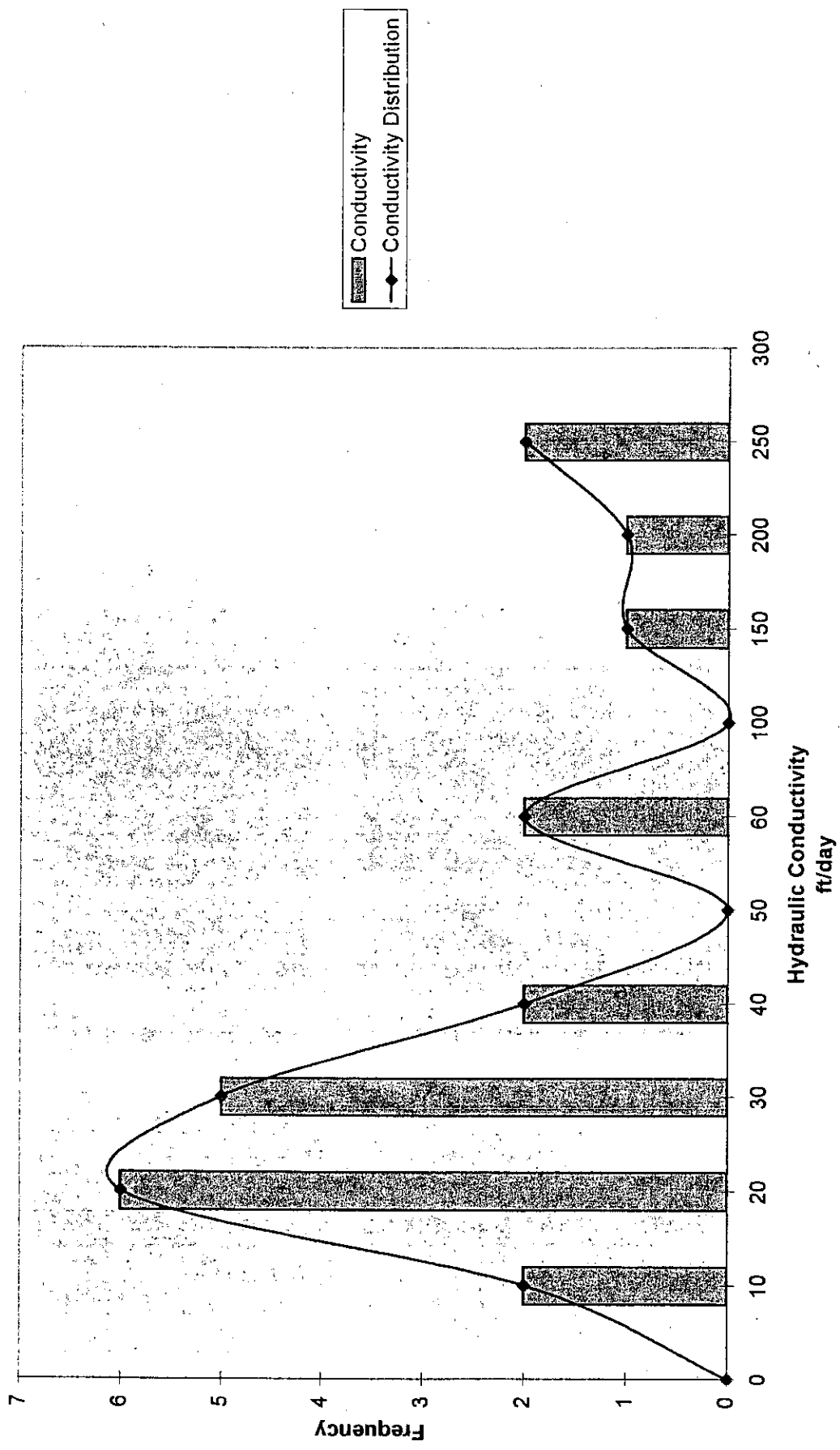

Conductivity
 Conductivity Distribution

GROUNDWATER/CONTAMINANT VELOCITY CALCULATIONS

For the purpose of this report, the x direction or axis will be aligned with the direction of groundwater flow and mean groundwater velocity can be expressed as:

$$\bar{V}_x = \frac{K}{n_e} \frac{\partial \phi}{\partial x} \quad (2)$$

Where:

| | | |
|---------------------------|---|---|
| K | = | mean hydraulic conductivity from slug test data (l/t) |
| V_x | = | mean groundwater flow velocity in the x direction (l/t) |
| n_e | = | effective porosity (dimensionless) |
| $\partial\phi/\partial x$ | = | hydraulic gradient or i (dimensionless) |

Using a typical value of 0.25 for the effective porosity of sand, the hydraulic gradient of 0.07% from the Site, and a hydraulic conductivity of 32 feet/day from the slug test data; the mean groundwater velocity calculated for the Site is 33 feet/year.

Of the VOCs associated with crude oil, benzene is typically the first compound to arrive downgradient in a groundwater plume. The velocity of the benzene traveling through the aquifer may be determined with equation (3).

$$V_c = \frac{V_x}{R_{benzene}} \quad (3)$$

Where:

| | | |
|---------------|---|--|
| V_x | = | groundwater flow velocity in the x direction (l/t) |
| $R_{benzene}$ | = | retardation factor for benzene |

The retardation factor is expressed as equation (4).

$$R_{benzene} = 1 + \frac{\rho_b}{\theta} K_d \quad (4)$$

Where:

| | | |
|-------|---|--|
| K_d | = | distribution coefficient (dimensionless) |
|-------|---|--|

ρ_b = bulk dry density of the soil (g/cm^3)
 θ = porosity

Equations (5) and (6) are combined to determine the distribution coefficient and the bulk dry density.

$$K_d = K_{oc} f_{oc} \quad (5)$$

$$n = 1 - \frac{\rho_b}{\rho_s} \quad (6)$$

Where:

- K_d = distribution coefficient (dimensionless)
- ρ_b = bulk dry density of the soil (g/cm^3)
- K_{oc} = partitioning coefficient for benzene (cm^3/g)
- f_{oc} = fraction organic carbon (dimensionless)
- ρ_s = particle mass density (g/cm^3)
- n = porosity (dimensionless)

Combining the above equations for retardation factor, the following equation is arrived at:

$$R = 1 + \left(\frac{\rho_b}{n_e}\right)(K_{oc} f_{oc}) \quad (7)$$

By making the following assumptions based on literature values and site data the contaminant velocity of benzene can be determined.

- $K_{oc} = 83 \text{ cm}^3/\text{g}$ for benzene
- $\rho_b = 2.0 \text{ g}/\text{cm}^3$ for sand
- $n_e = 0.25$ for sand
- $f_{oc} = 0.09\%$ @ MW-1

For the South Cass Lake Station, the retardation factor is 1.59, giving a mean V_{benzene} of 21 feet/year.

The velocity of crude oil was calculated using the following equation assuming a viscosity of 500 cSt at 5 °C, a gradient of 0.07%, hydraulic conductivity of 32 ft/day and a porosity of 0.25:

$$V_{oil} = (-Kg/v\eta) * d\Phi/dx$$

where:

V_{oil} = oil velocity (L/T)

K = hydraulic conductivity (L/T)

g = gravity (L/T²)

v = kinematic viscosity (cSt)

η = unitless

$d\Phi/dx$ = horizontal hydraulic gradient (L)

It was calculated that the velocity of the oil at the South Cass Lake Station is traveling at a velocity of approximately 0.5 ft/year.

APPENDIX C – CRUDE OIL VISCOSITY ANALYSIS

Crude Oil Kinematic Viscosity Summary
Enbridge Pipelines (Lakehead), L.L.C. - South Cass Lake Station

| <u>Location</u> | <u>Temperature (°C)</u> | <u>Kinematic Viscosity (cSt)</u> |
|-----------------|-------------------------|----------------------------------|
| MW-5 | 10 | 421.05 |
| | 20 | 206.74 |
| | 30 | 112.71 |
| MW-11 | 10 | 82.18 |
| | 20 | 47.53 |
| | 30 | 30.2 |
| MW-13 | 10 | 23.58 |
| | 20 | 15.56 |
| | 30 | 10.91 |

**Crude Oil Viscosity: MW-5
Enbridge Pipelines (Lakehead), L.L.C. - South Cass Lake Station**

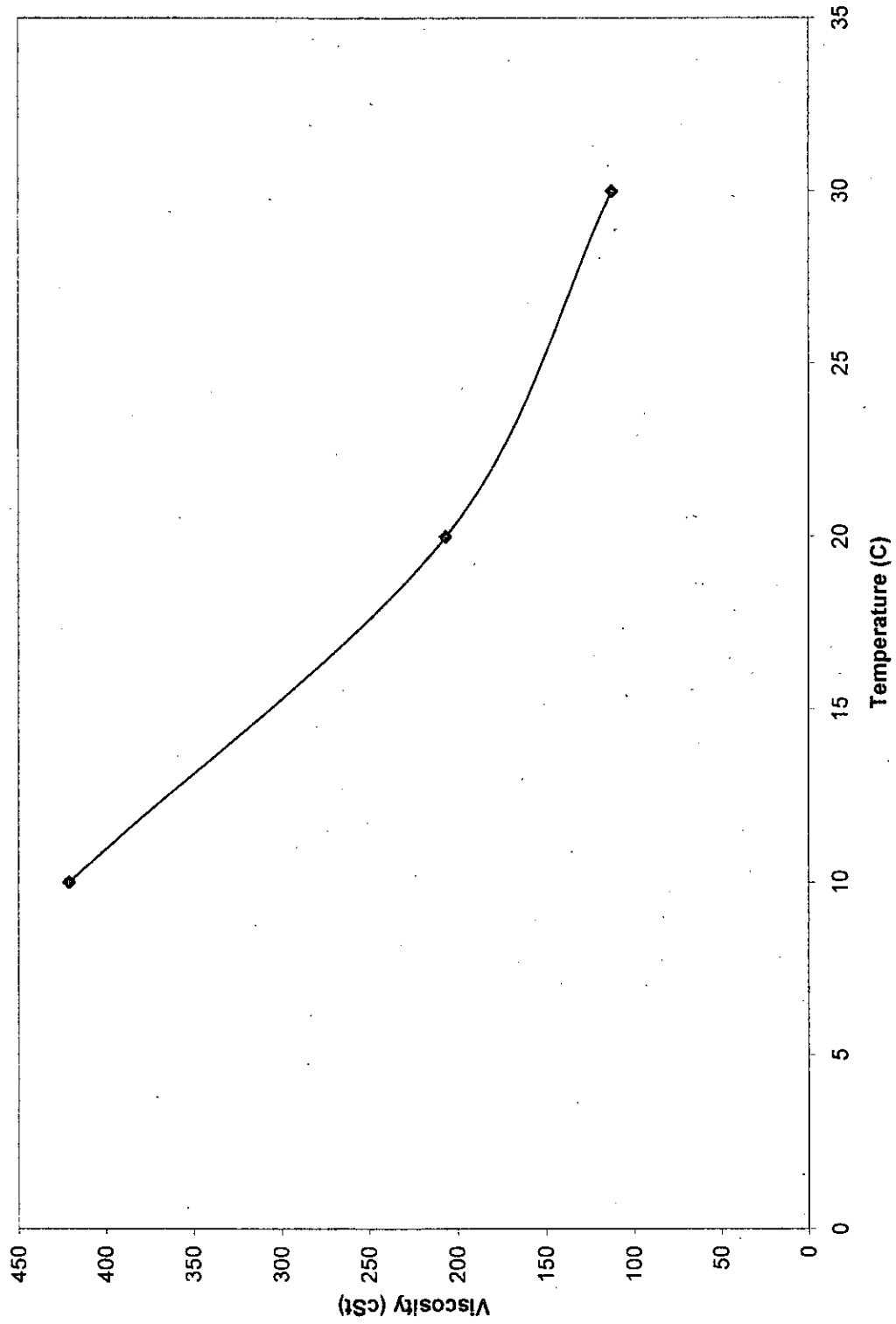

—◆— Viscosity

**Crude Oil Viscosity: MW-11
Enbridge Pipelines (Lakehead), L.L.C. - South Cass Lake Station**

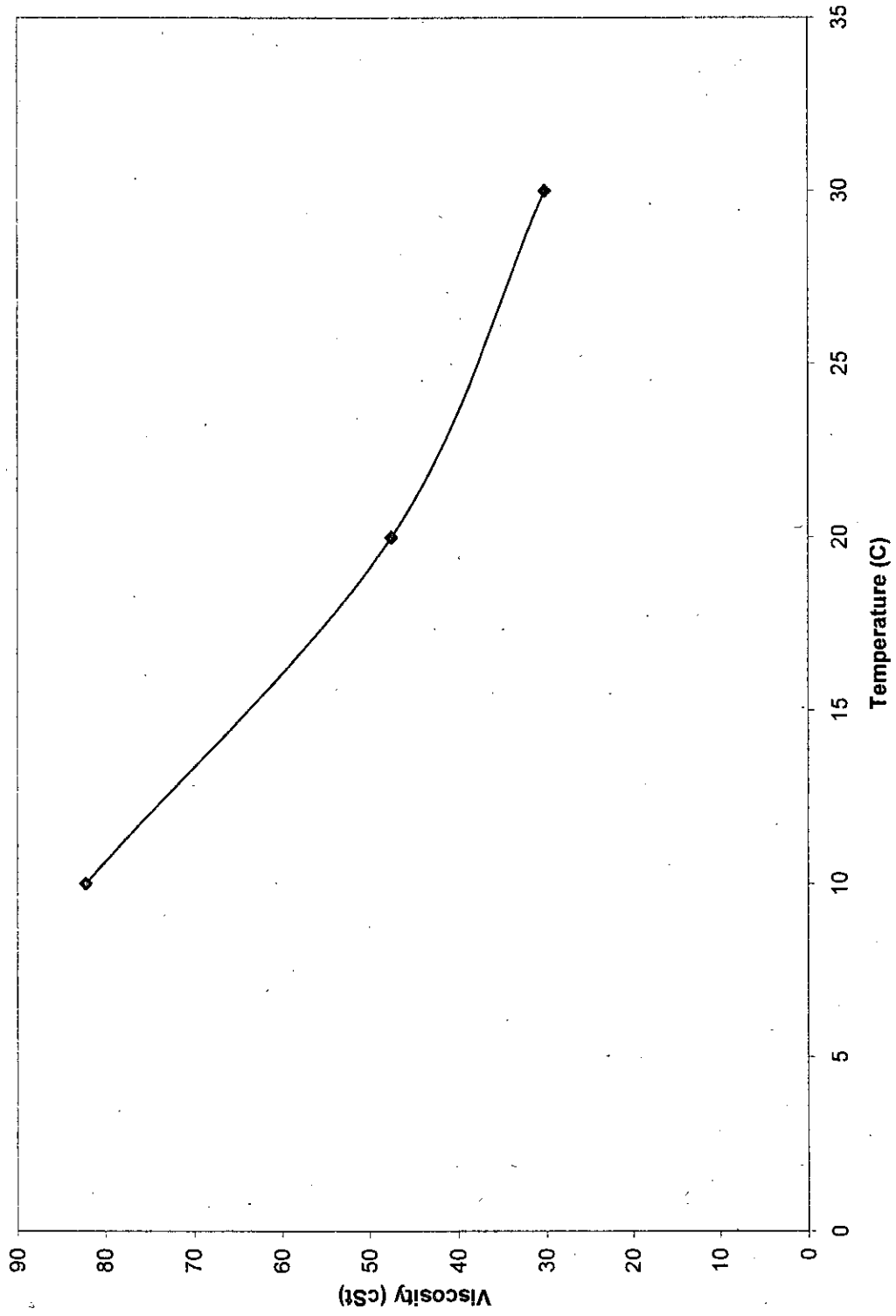

—◆— viscosity

**Crude Oil Viscosity: MW-13
Enbridge Pipelines (Lakehead), L.L.C. - South Cass Lake Station**

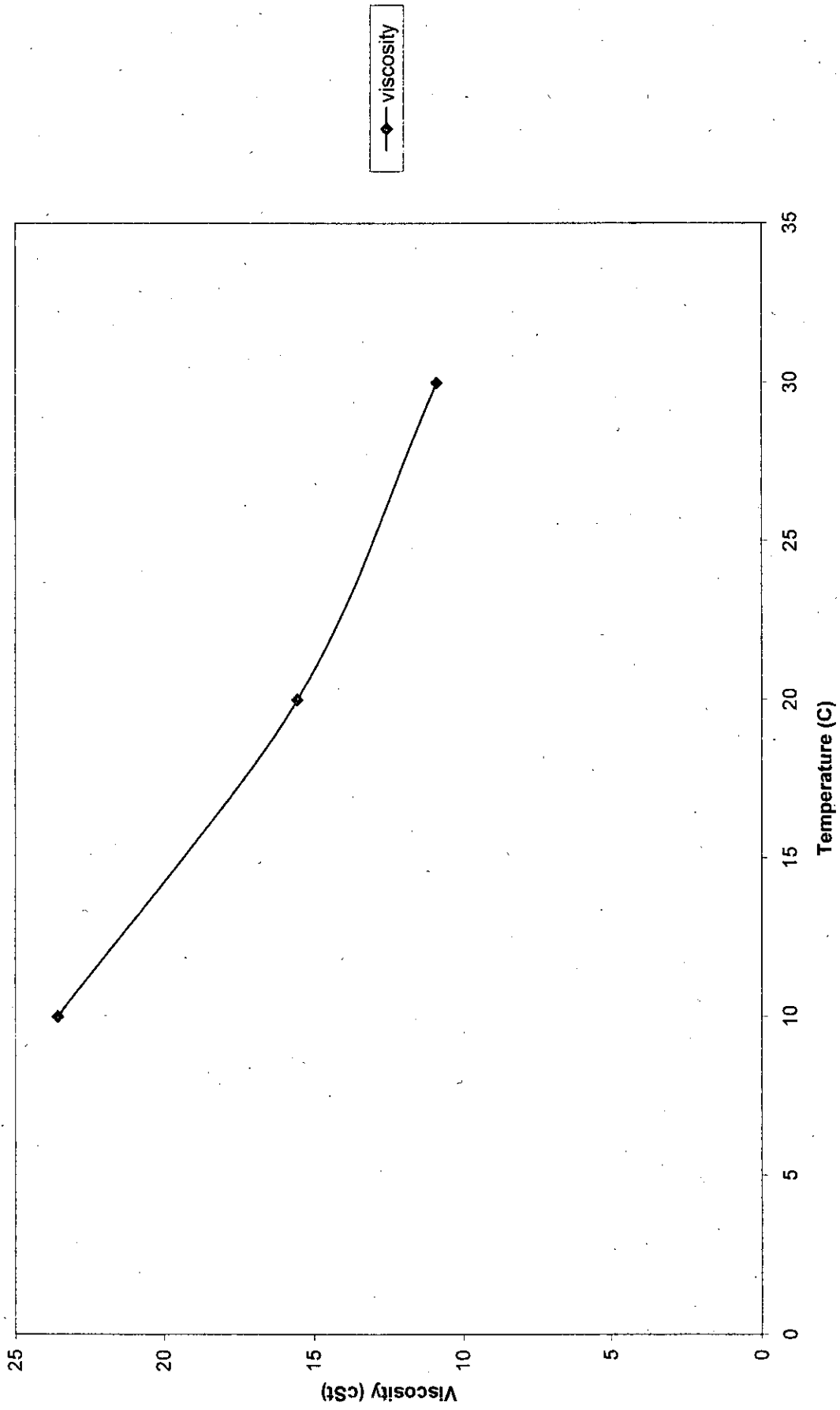

—◆— viscosity

APPENDIX D – LABORATORY ANALYTICAL REPORT

Analytical Report Number: 842713

Client : NREC

Project Name : SOUTH CASS LAKE

Project Number :

| Lab Sample Number | Field ID | Matrix | Collection Date |
|-------------------|----------|--------|-----------------|
| 842713-001 | MW-1 | WATER | 01/06/04 |
| 842713-002 | MW-2 | WATER | 01/06/04 |
| 842713-003 | MW-4 | WATER | 01/06/04 |
| 842713-004 | MW-5 | WATER | 01/06/04 |
| 842713-005 | MW-6 | WATER | 01/06/04 |
| 842713-006 | MW-7 | WATER | 01/06/04 |
| 842713-007 | MW-8 | WATER | 01/06/04 |
| 842713-008 | MW-9 | WATER | 01/06/04 |
| 842713-009 | MW-10 | WATER | 01/05/04 |

I certify that the data contained in this Final Report has been generated and reviewed in accordance with approved methods and Laboratory Standard Operating Procedure. Exceptions, if any, are discussed in the accompanying sample comments. Release of this final report is authorized by Laboratory management, as is verified by the following signature. Reported results shall not be reproduced, except in full, without the written approval of the lab. The sample results relate only to the analytes of interest tested.

Approval Signature

1/19/04
Date

En Chem Inc.

Analytical Report Number: 842713

1241 Bellevue Street
Green Bay, WI 54302
920-469-2436

Client : NREC
Project Name : SOUTH CASS LAKE
Project Number :
Field ID : MW-1

Matrix Type : WATER
Collection Date : 01/06/04
Report Date : 01/15/04
Lab Sample Number : 842713-001

INORGANICS

| Test. | Result | EQL | Dilution | Units | Code | Anl Date | Prep Method | Anl Method |
|----------------------|--------|------|----------|-------|------|----------|-------------|------------|
| Nickel - Dissolved | < 3.0 | 3.0 | 1 | ug/L | | 01/14/04 | SW846 6020 | SW846 6020 |
| Vanadium - Dissolved | 3.7 | 3.0 | 1 | ug/L | | 01/14/04 | SW846 6020 | SW846 6020 |
| Nitrogen, NO3 + NO2 | 2.1 | 0.25 | 1 | mg/L | | 01/13/04 | EPA 353.2 | EPA 353.2 |
| Sulfate | 6.3 | 4.0 | 1 | mg/L | | 01/12/04 | EPA 300.0 | EPA 300.0 |

DRO Extended Range C10-C40

Prep Date: 01/12/04

| Analyte | Result | EQL | Dilution | Units | Code | Anl Date | Prep Method | Anl Method |
|------------------------------|--------|-----|----------|--------|------|----------|-------------|------------|
| DRO Ext. Range C10 - C40 | < 110 | 110 | 1 | ug/L | | 01/13/04 | WI MOD DRO | WI MOD DRO |
| DRO Ext. Range C10 - C40 BLK | < 100 | 100 | 1 | ug/L | | 01/13/04 | WI MOD DRO | WI MOD DRO |
| DRO Ext. Range C10 - C40 BS | 87 | --- | 1 | %Recov | | 01/13/04 | WI MOD DRO | WI MOD DRO |
| DRO Ext. Range C10 - C40 BSD | 88 | --- | 1 | %Recov | | 01/13/04 | WI MOD DRO | WI MOD DRO |

BTEX

Prep Date: 01/12/04

| Analyte | Result | EQL | Dilution | Units | Code | Anl Date | Prep Method | Anl Method |
|------------------------|--------|-----|----------|--------|------|----------|-------------|--------------|
| Benzene | < 1.0 | 1.0 | 1 | ug/L | | 01/12/04 | SW846 5030B | SW846 M8021B |
| Ethylbenzene | < 1.0 | 1.0 | 1 | ug/L | | 01/12/04 | SW846 5030B | SW846 M8021B |
| Toluene | < 1.0 | 1.0 | 1 | ug/L | | 01/12/04 | SW846 5030B | SW846 M8021B |
| Xylene, o | < 1.0 | 1.0 | 1 | ug/L | | 01/12/04 | SW846 5030B | SW846 M8021B |
| Xylenes, m + p | < 2.0 | 2.0 | 1 | ug/L | | 01/12/04 | SW846 5030B | SW846 M8021B |
| a,a,a-Trifluorotoluene | 106 | --- | 1 | %Recov | | 01/12/04 | SW846 5030B | SW846 M8021B |

BTEX BLANK

Prep Date: 01/12/04

| Analyte | Result | EQL | Dilution | Units | Code | Anl Date | Prep Method | Anl Method |
|---------------|---------|-----|----------|-------|------|----------|-------------|------------|
| BTEX Blank ID | 1356-92 | | 1 | | | | | |

En Chem Inc.

Analytical Report Number: 842713

1241 Bellevue Street
Green Bay, WI 54302
920-469-2436

Client : NREC
Project Name : SOUTH CASS LAKE
Project Number :
Field ID : MW-2

Matrix Type : WATER
Collection Date : 01/06/04
Report Date : 01/15/04
Lab Sample Number : 842713-002

INORGANICS

| Test | Result | EQL | Dilution | Units | Code | Anl Date | Prep Method | Anl Method |
|----------------------|--------|------|----------|-------|------|----------|-------------|------------|
| Nickel - Dissolved | < 3.0 | 3.0 | 1 | ug/L | | 01/14/04 | SW846 6020 | SW846 6020 |
| Vanadium - Dissolved | 5.0 | 3.0 | 1 | ug/L | | 01/14/04 | SW846 6020 | SW846 6020 |
| Nitrogen, NO3 + NO2 | 4.1 | 0.25 | 1 | mg/L | | 01/13/04 | EPA 353.2 | EPA 353.2 |
| Sulfate | < 4.0 | 4.0 | 1 | mg/L | | 01/12/04 | EPA 300.0 | EPA 300.0 |

DRO Extended Range C10-C40

Prep Date: 01/12/04

| Analyte | Result | EQL | Dilution | Units | Code | Anl Date | Prep Method | Anl Method |
|------------------------------|--------|-----|----------|--------|------|----------|-------------|------------|
| DRO Ext. Range C10 - C40 | < 100 | 100 | 1 | ug/L | | 01/13/04 | WI MOD DRO | WI MOD DRO |
| DRO Ext. Range C10 - C40 BLK | < 100 | 100 | 1 | ug/L | | 01/13/04 | WI MOD DRO | WI MOD DRO |
| DRO Ext. Range C10 - C40 BS | 87 | --- | 1 | %Recov | | 01/13/04 | WI MOD DRO | WI MOD DRO |
| DRO Ext. Range C10 - C40 BSD | 88 | --- | 1 | %Recov | | 01/13/04 | WI MOD DRO | WI MOD DRO |

BTEX

Prep Date: 01/12/04

| Analyte | Result | EQL | Dilution | Units | Code | Anl Date | Prep Method | Anl Method |
|------------------------|--------|-----|----------|--------|------|----------|-------------|--------------|
| Benzene | < 1.0 | 1.0 | 1 | ug/L | | 01/12/04 | SW846 5030B | SW846 M8021B |
| Ethylbenzene | < 1.0 | 1.0 | 1 | ug/L | | 01/12/04 | SW846 5030B | SW846 M8021B |
| Toluene | < 1.0 | 1.0 | 1 | ug/L | | 01/12/04 | SW846 5030B | SW846 M8021B |
| Xylene, o | < 1.0 | 1.0 | 1 | ug/L | | 01/12/04 | SW846 5030B | SW846 M8021B |
| Xylenes, m + p | < 2.0 | 2.0 | 1 | ug/L | | 01/12/04 | SW846 5030B | SW846 M8021B |
| a,a,a-Trifluorotoluene | 106 | --- | 1 | %Recov | | 01/12/04 | SW846 5030B | SW846 M8021B |

BTEX BLANK

Prep Date: 01/12/04

| Analyte | Result | EQL | Dilution | Units | Code | Anl Date | Prep Method | Anl Method |
|---------------|---------|-----|----------|-------|------|----------|-------------|------------|
| BTEX Blank ID | 1356-92 | | 1 | | | | | |

En Chem Inc.

Analytical Report Number: 842713

1241 Bellevue Street
Green Bay, WI 54302
920-469-2436

Client : NREC
Project Name : SOUTH CASS LAKE
Project Number :
Field ID : MW-4

Matrix Type : WATER
Collection Date : 01/06/04
Report Date : 01/15/04
Lab Sample Number : 842713-003

INORGANICS

| Test | Result | EQL | Dilution | Units | Code | Anl Date | Prep Method | Anl Method |
|----------------------|--------|------|----------|-------|------|----------|-------------|------------|
| Nickel - Dissolved | < 3.0 | 3.0 | 1 | ug/L | | 01/14/04 | SW846 6020 | SW846 6020 |
| Vanadium - Dissolved | < 3.0 | 3.0 | 1 | ug/L | | 01/14/04 | SW846 6020 | SW846 6020 |
| Nitrogen, NO3 + NO2 | 1.0 | 0.25 | 1 | mg/L | | 01/13/04 | EPA 353.2 | EPA 353.2 |
| Sulfate | < 4.0 | 4.0 | 1 | mg/L | | 01/12/04 | EPA 300.0 | EPA 300.0 |

DRO Extended Range C10-C40

Prep Date: 01/12/04

| Analyte | Result | EQL | Dilution | Units | Code | Anl Date | Prep Method | Anl Method |
|------------------------------|--------|-----|----------|--------|------|----------|-------------|------------|
| DRO Ext. Range C10 - C40 | < 100 | 100 | 1 | ug/L | | 01/13/04 | WI MOD DRO | WI MOD DRO |
| DRO Ext. Range C10 - C40 BLK | < 100 | 100 | 1 | ug/L | | 01/13/04 | WI MOD DRO | WI MOD DRO |
| DRO Ext. Range C10 - C40 BS | 87 | --- | 1 | %Recov | | 01/13/04 | WI MOD DRO | WI MOD DRO |
| DRO Ext. Range C10 - C40 BSD | 88 | --- | 1 | %Recov | | 01/13/04 | WI MOD DRO | WI MOD DRO |

BTEX

Prep Date: 01/12/04

| Analyte | Result | EQL | Dilution | Units | Code | Anl Date | Prep Method | Anl Method |
|------------------------|--------|-----|----------|--------|------|----------|-------------|--------------|
| Benzene | < 1.0 | 1.0 | 1 | ug/L | | 01/12/04 | SW846 5030B | SW846 M8021B |
| Ethylbenzene | < 1.0 | 1.0 | 1 | ug/L | | 01/12/04 | SW846 5030B | SW846 M8021B |
| Toluene | < 1.0 | 1.0 | 1 | ug/L | | 01/12/04 | SW846 5030B | SW846 M8021B |
| Xylene, o | < 1.0 | 1.0 | 1 | ug/L | | 01/12/04 | SW846 5030B | SW846 M8021B |
| Xylenes, m + p | < 2.0 | 2.0 | 1 | ug/L | | 01/12/04 | SW846 5030B | SW846 M8021B |
| a,a,a-Trifluorotoluene | 106 | --- | 1 | %Recov | | 01/12/04 | SW846 5030B | SW846 M8021B |

BTEX BLANK

Prep Date: 01/12/04

| Analyte | Result | EQL | Dilution | Units | Code | Anl Date | Prep Method | Anl Method |
|---------------|---------|-----|----------|-------|------|----------|-------------|------------|
| BTEX Blank ID | 1356-92 | | 1 | | | | | |

En Chem Inc.

Analytical Report Number: 842713

1241 Bellevue Street
Green Bay, WI 54302
920-469-2436

Client : NREC
Project Name : SOUTH CASS LAKE
Project Number :
Field ID : MW-5

Matrix Type : WATER
Collection Date : 01/06/04
Report Date : 01/15/04
Lab Sample Number : 842713-004

BTEX

Prep Date: 01/12/04

| Analyte | Result | EQL | Dilution | Units | Code | Anl Date | Prep Method | Anl Method |
|------------------------|--------|-----|----------|--------|------|----------|-------------|--------------|
| Benzene | 6500 | 50 | 50 | ug/L | | 01/12/04 | SW846 5030B | SW846 M8021B |
| Ethylbenzene | 530 | 50 | 50 | ug/L | | 01/12/04 | SW846 5030B | SW846 M8021B |
| Toluene | < 50 | 50 | 50 | ug/L | | 01/12/04 | SW846 5030B | SW846 M8021B |
| Xylene, o | < 50 | 50 | 50 | ug/L | | 01/12/04 | SW846 5030B | SW846 M8021B |
| Xylenes, m + p | 1800 | 100 | 50 | ug/L | | 01/12/04 | SW846 5030B | SW846 M8021B |
| a,a,a-Trifluorotoluene | 106 | -- | 1 | %Recov | | 01/12/04 | SW846 5030B | SW846 M8021B |

BTEX BLANK

Prep Date: 01/12/04

| Analyte | Result | EQL | Dilution | Units | Code | Anl Date | Prep Method | Anl Method |
|---------------|---------|-----|----------|-------|------|----------|-------------|------------|
| BTEX Blank ID | 1356-92 | | 1 | | | | | |

Client : NREC
Project Name : SOUTH CASS LAKE
Project Number :
Field ID : MW-6Matrix Type : WATER
Collection Date : 01/06/04
Report Date : 01/15/04
Lab Sample Number : 842713-005

INORGANICS

| Test | Result | EQL | Dilution | Units | Code | Anl Date | Prep Method | Anl Method |
|----------------------|--------|------|----------|-------|------|----------|-------------|------------|
| Nickel - Dissolved | < 3.0 | 3.0 | 1 | ug/L | | 01/14/04 | SW846 6020 | SW846 6020 |
| Vanadium - Dissolved | 3.1 | 3.0 | 1 | ug/L | | 01/14/04 | SW846 6020 | SW846 6020 |
| Nitrogen, NO3 + NO2 | 1.9 | 0.25 | 1 | mg/L | | 01/13/04 | EPA 353.2 | EPA 353.2 |
| Sulfate | 5.4 | 4.0 | 1 | mg/L | | 01/12/04 | EPA 300.0 | EPA 300.0 |

DRO Extended Range C10-C40

Prep Date: 01/12/04

| Analyte | Result | EQL | Dilution | Units | Code | Anl Date | Prep Method | Anl Method |
|------------------------------|--------|-----|----------|--------|------|----------|-------------|------------|
| DRO Ext. Range C10 - C40 | < 100 | 100 | 1 | ug/L | | 01/13/04 | WI MOD DRO | WI MOD DRO |
| DRO Ext. Range C10 - C40 BLK | < 100 | 100 | 1 | ug/L | | 01/13/04 | WI MOD DRO | WI MOD DRO |
| DRO Ext. Range C10 - C40 BS | 87 | --- | 1 | %Recov | | 01/13/04 | WI MOD DRO | WI MOD DRO |
| DRO Ext. Range C10 - C40 BSD | 88 | --- | 1 | %Recov | | 01/13/04 | WI MOD DRO | WI MOD DRO |

BTEX

Prep Date: 01/12/04

| Analyte | Result | EQL | Dilution | Units | Code | Anl Date | Prep Method | Anl Method |
|------------------------|--------|-----|----------|--------|------|----------|-------------|--------------|
| Benzene | < 1.0 | 1.0 | 1 | ug/L | | 01/12/04 | SW846 5030B | SW846 M8021B |
| Ethylbenzene | < 1.0 | 1.0 | 1 | ug/L | | 01/12/04 | SW846 5030B | SW846 M8021B |
| Toluene | < 1.0 | 1.0 | 1 | ug/L | | 01/12/04 | SW846 5030B | SW846 M8021B |
| Xylene, o | < 1.0 | 1.0 | 1 | ug/L | | 01/12/04 | SW846 5030B | SW846 M8021B |
| Xylenes, m + p | < 2.0 | 2.0 | 1 | ug/L | | 01/12/04 | SW846 5030B | SW846 M8021B |
| a,a,a-Trifluorotoluene | 106 | --- | 1 | %Recov | | 01/12/04 | SW846 5030B | SW846 M8021B |

BTEX BLANK

Prep Date: 01/12/04

| Analyte | Result | EQL | Dilution | Units | Code | Anl Date | Prep Method | Anl Method |
|---------------|---------|-----|----------|-------|------|----------|-------------|------------|
| BTEX Blank ID | 1356-92 | | 1 | | | | | |

Client : NREC
Project Name : SOUTH CASS LAKE
Project Number :
Field ID : MW-7

Matrix Type : WATER
Collection Date : 01/06/04
Report Date : 01/15/04
Lab Sample Number : 842713-006

INORGANICS

| Test | Result | EQL | Dilution | Units | Code | Anl Date | Prep Method | Anl Method |
|----------------------|--------|------|----------|-------|------|----------|-------------|------------|
| Nickel - Dissolved | < 3.0 | 3.0 | 1 | ug/L | | 01/14/04 | SW846 6020 | SW846 6020 |
| Vanadium - Dissolved | < 3.0 | 3.0 | 1 | ug/L | | 01/14/04 | SW846 6020 | SW846 6020 |
| Nitrogen, NO3 + NO2 | < 0.25 | 0.25 | 1 | mg/L | | 01/13/04 | EPA 353.2 | EPA 353.2 |
| Sulfate | 5.7 | 4.0 | 1 | mg/L | | 01/12/04 | EPA 300.0 | EPA 300.0 |

DRO Extended Range C10-C40

Prep Date: 01/12/04

| Analyte | Result | EQL | Dilution | Units | Code | Anl Date | Prep Method | Anl Method |
|------------------------------|--------|-----|----------|--------|------|----------|-------------|------------|
| DRO Ext. Range C10 - C40 | < 100 | 100 | 1 | ug/L | | 01/13/04 | WI MOD DRO | WI MOD DRO |
| DRO Ext. Range C10 - C40 BLK | < 100 | 100 | 1 | ug/L | | 01/13/04 | WI MOD DRO | WI MOD DRO |
| DRO Ext. Range C10 - C40 BS | 87 | --- | 1 | %Recov | | 01/13/04 | WI MOD DRO | WI MOD DRO |
| DRO Ext. Range C10 - C40 BSD | 88 | --- | 1 | %Recov | | 01/13/04 | WI MOD DRO | WI MOD DRO |

BTEX

Prep Date: 01/12/04

| Analyte | Result | EQL | Dilution | Units | Code | Anl Date | Prep Method | Anl Method |
|------------------------|--------|-----|----------|--------|------|----------|-------------|--------------|
| Benzene | < 1.0 | 1.0 | 1 | ug/L | | 01/12/04 | SW846 5030B | SW846 M8021B |
| Ethylbenzene | < 1.0 | 1.0 | 1 | ug/L | | 01/12/04 | SW846 5030B | SW846 M8021B |
| Toluene | < 1.0 | 1.0 | 1 | ug/L | | 01/12/04 | SW846 5030B | SW846 M8021B |
| Xylene, o | < 1.0 | 1.0 | 1 | ug/L | | 01/12/04 | SW846 5030B | SW846 M8021B |
| Xylenes, m + p | < 2.0 | 2.0 | 1 | ug/L | | 01/12/04 | SW846 5030B | SW846 M8021B |
| a,a,a-Trifluorotoluene | 106 | --- | 1 | %Recov | | 01/12/04 | SW846 5030B | SW846 M8021B |

BTEX BLANK

Prep Date: 01/12/04

| Analyte | Result | EQL | Dilution | Units | Code | Anl Date | Prep Method | Anl Method |
|---------------|---------|-----|----------|-------|------|----------|-------------|------------|
| BTEX Blank ID | 1356-92 | | 1 | | | | | |

Client : NREC
Project Name : SOUTH CASS LAKE
Project Number :
Field ID : MW-8

Matrix Type : WATER
Collection Date : 01/06/04
Report Date : 01/15/04
Lab Sample Number : 842713-007

INORGANICS

| Test | Result | EQL | Dilution | Units | Code | Anl Date | Prep Method | Anl Method |
|----------------------|--------|------|----------|-------|------|----------|-------------|------------|
| Nickel - Dissolved | < 3.0 | 3.0 | 1 | ug/L | | 01/14/04 | SW846 6020 | SW846 6020 |
| Vanadium - Dissolved | 3.9 | 3.0 | 1 | ug/L | | 01/14/04 | SW846 6020 | SW846 6020 |
| Nitrogen, NO3 + NO2 | 0.34 | 0.25 | 1 | mg/L | | 01/13/04 | EPA 353.2 | EPA 353.2 |
| Sulfate | 5.5 | 4.0 | 1 | mg/L | | 01/12/04 | EPA 300.0 | EPA 300.0 |

DRO Extended Range C10-C40

Prep Date: 01/12/04

| Analyte | Result | EQL | Dilution | Units | Code | Anl Date | Prep Method | Anl Method |
|------------------------------|--------|-----|----------|--------|------|----------|-------------|------------|
| DRO Ext. Range C10 - C40 | < 100 | 100 | 1 | ug/L | | 01/13/04 | WI MOD DRO | WI MOD DRO |
| DRO Ext. Range C10 - C40 BLK | < 100 | 100 | 1 | ug/L | | 01/13/04 | WI MOD DRO | WI MOD DRO |
| DRO Ext. Range C10 - C40 BS | 87 | --- | 1 | %Recov | | 01/13/04 | WI MOD DRO | WI MOD DRO |
| DRO Ext. Range C10 - C40 BSD | 88 | --- | 1 | %Recov | | 01/13/04 | WI MOD DRO | WI MOD DRO |

BTEX

Prep Date: 01/12/04

| Analyte | Result | EQL | Dilution | Units | Code | Anl Date | Prep Method | Anl Method |
|------------------------|--------|-----|----------|--------|------|----------|-------------|--------------|
| Benzene | < 1.0 | 1.0 | 1 | ug/L | | 01/12/04 | SW846 5030B | SW846 M8021B |
| Ethylbenzene | < 1.0 | 1.0 | 1 | ug/L | | 01/12/04 | SW846 5030B | SW846 M8021B |
| Toluene | < 1.0 | 1.0 | 1 | ug/L | | 01/12/04 | SW846 5030B | SW846 M8021B |
| Xylene, o | < 1.0 | 1.0 | 1 | ug/L | | 01/12/04 | SW846 5030B | SW846 M8021B |
| Xylenes, m + p | < 2.0 | 2.0 | 1 | ug/L | | 01/12/04 | SW846 5030B | SW846 M8021B |
| a,a,a-Trifluorotoluene | 106 | --- | 1 | %Recov | | 01/12/04 | SW846 5030B | SW846 M8021B |

BTEX BLANK

Prep Date: 01/12/04

| Analyte | Result | EQL | Dilution | Units | Code | Anl Date | Prep Method | Anl Method |
|---------------|---------|-----|----------|-------|------|----------|-------------|------------|
| BTEX Blank ID | 1356-92 | | 1 | | | | | |

Client : NREC
Project Name : SOUTH CASS LAKE
Project Number :
Field ID : MW-9

Matrix Type : WATER
Collection Date : 01/06/04
Report Date : 01/15/04
Lab Sample Number : 842713-008

INORGANICS

| Test | Result | EQL | Dilution | Units | Code | Anl Date | Prep Method | Anl Method |
|----------------------|--------|------|----------|-------|------|----------|-------------|------------|
| Nickel - Dissolved | < 3.0 | 3.0 | 1 | ug/L | | 01/14/04 | SW846 6020 | SW846 6020 |
| Vanadium - Dissolved | 3.9 | 3.0 | 1 | ug/L | | 01/14/04 | SW846 6020 | SW846 6020 |
| Nitrogen, NO3 + NO2 | < 0.25 | 0.25 | 1 | mg/L | | 01/13/04 | EPA 353.2 | EPA 353.2 |
| Sulfate | 6.3 | 4.0 | 1 | mg/L | | 01/12/04 | EPA 300.0 | EPA 300.0 |

DRO Extended Range C10-C40

Prep Date: 01/12/04

| Analyte | Result | EQL | Dilution | Units | Code | Anl Date | Prep Method | Anl Method |
|------------------------------|--------|-----|----------|--------|------|----------|-------------|------------|
| DRO Ext. Range C10 - C40 | < 100 | 100 | 1 | ug/L | | 01/13/04 | WI MOD DRO | WI MOD DRO |
| DRO Ext. Range C10 - C40 BLK | < 100 | 100 | 1 | ug/L | | 01/13/04 | WI MOD DRO | WI MOD DRO |
| DRO Ext. Range C10 - C40 BS | 87 | --- | 1 | %Recov | | 01/13/04 | WI MOD DRO | WI MOD DRO |
| DRO Ext. Range C10 - C40 BSD | 88 | --- | 1 | %Recov | | 01/13/04 | WI MOD DRO | WI MOD DRO |

BTEX

Prep Date: 01/12/04

| Analyte | Result | EQL | Dilution | Units | Code | Anl Date | Prep Method | Anl Method |
|------------------------|--------|-----|----------|--------|------|----------|-------------|--------------|
| Benzene | < 1.0 | 1.0 | 1 | ug/L | | 01/12/04 | SW846 5030B | SW846 M8021B |
| Ethylbenzene | < 1.0 | 1.0 | 1 | ug/L | | 01/12/04 | SW846 5030B | SW846 M8021B |
| Toluene | < 1.0 | 1.0 | 1 | ug/L | | 01/12/04 | SW846 5030B | SW846 M8021B |
| Xylene, o | < 1.0 | 1.0 | 1 | ug/L | | 01/12/04 | SW846 5030B | SW846 M8021B |
| Xylenes, m + p | < 2.0 | 2.0 | 1 | ug/L | | 01/12/04 | SW846 5030B | SW846 M8021B |
| a,a,a-Trifluorotoluene | 106 | --- | 1 | %Recov | | 01/12/04 | SW846 5030B | SW846 M8021B |

BTEX BLANK

Prep Date: 01/12/04

| Analyte | Result | EQL | Dilution | Units | Code | Anl Date | Prep Method | Anl Method |
|---------------|---------|-----|----------|-------|------|----------|-------------|------------|
| BTEX Blank ID | 1356-92 | | 1 | | | | | |

Client: NREC

Project Name: SOUTH CASS LAKE

Project Number:

Field ID: MW-10

Matrix Type: WATER

Collection Date: 01/05/04

Report Date: 01/15/04

Lab Sample Number: 842713-009

INORGANICS

| Test | Result | EQL | Dilution | Units | Code | Anl Date | Prep Method | Anl Method |
|----------------------|--------|------|----------|-------|------|----------|-------------|------------|
| Nickel - Dissolved | 14 | 3.0 | 1 | ug/L | | 01/14/04 | SW846 6020 | SW846 6020 |
| Vanadium - Dissolved | 3.8 | 3.0 | 1 | ug/L | E | 01/14/04 | SW846 6020 | SW846 6020 |
| Nitrogen, NO3 + NO2 | < 0.25 | 0.25 | 1 | mg/L | | 01/13/04 | EPA 353.2 | EPA 353.2 |
| Sulfate | < 4.0 | 4.0 | 1 | mg/L | | 01/12/04 | EPA 300.0 | EPA 300.0 |

DRO Extended Range C10-C40

Prep Date: 01/12/04

| Analyte | Result | EQL | Dilution | Units | Code | Anl Date | Prep Method | Anl Method |
|------------------------------|--------|-----|----------|--------|------|----------|-------------|------------|
| DRO Ext. Range C10 - C40 | 30000 | 800 | 8 | ug/L | | 01/13/04 | WI MOD DRO | WI MOD DRO |
| DRO Ext. Range C10 - C40 BLK | < 100 | 100 | 1 | ug/L | | 01/13/04 | WI MOD DRO | WI MOD DRO |
| DRO Ext. Range C10 - C40 BS | 87 | --- | 1 | %Recov | | 01/13/04 | WI MOD DRO | WI MOD DRO |
| DRO Ext. Range C10 - C40 BSD | 88 | --- | 1 | %Recov | | 01/13/04 | WI MOD DRO | WI MOD DRO |

BTEX

Prep Date: 01/12/04

| Analyte | Result | EQL | Dilution | Units | Code | Anl Date | Prep Method | Anl Method |
|------------------------|--------|-----|----------|--------|------|----------|-------------|--------------|
| Benzene | 1100 | 5.0 | 5 | ug/L | | 01/12/04 | SW846 5030B | SW846 M8021B |
| Ethylbenzene | 110 | 5.0 | 5 | ug/L | | 01/12/04 | SW846 5030B | SW846 M8021B |
| Toluene | < 5.0 | 5.0 | 5 | ug/L | | 01/12/04 | SW846 5030B | SW846 M8021B |
| Xylene, o | < 5.0 | 5.0 | 5 | ug/L | | 01/12/04 | SW846 5030B | SW846 M8021B |
| Xylenes, m + p | 520 | 10 | 5 | ug/L | | 01/12/04 | SW846 5030B | SW846 M8021B |
| a,a,a-Trifluorotoluene | 103 | --- | 1 | %Recov | | 01/12/04 | SW846 5030B | SW846 M8021B |

BTEX BLANK

Prep Date: 01/12/04

| Analyte | Result | EQL | Dilution | Units | Code | Anl Date | Prep Method | Anl Method |
|---------------|---------|-----|----------|-------|------|----------|-------------|------------|
| BTEX Blank ID | 1356-92 | | 1 | | | | | |

En Chem Inc.

1241 Bellevue Street
Green Bay, WI 54302
920-469-2436
800-7-ENCHEM
Fax: 920-469-8827

| Lab Number | TestGroupID | Field ID | Comment |
|------------|-------------|----------|---|
| 842713-009 | DRO+ER-W | MW-10 | Front eluting peaks, late eluting hump and diesel range peaks were present in the chromatogram. |

Qualifier Codes

| Flag | Applies To | Explanation |
|------|------------|---|
| A | Inorganic | Analyte is detected in the method blank. Method blank criteria is evaluated to the laboratory method detection limit. Additionally, method blank acceptance may be based on project specific criteria or determined from analyte concentrations in the sample and are evaluated on a sample by sample basis. |
| B | Inorganic | The analyte has been detected between the method detection limit and the reporting limit. |
| B | Organic | Analyte is present in the method blank. Method blank criteria is evaluated to the laboratory method detection limit. Additionally, method blank acceptance may be based on project specific criteria or determined from analyte concentrations in the sample and are evaluated on a sample by sample basis. |
| C | All | Elevated detection limit. |
| D | All | Analyte value from diluted analysis or surrogate result not applicable due to sample dilution. |
| E | Inorganic | Estimated concentration due to matrix interferences. During the metals analysis the serial dilution failed to meet the established control limits of 0-10%. The sample concentration is greater than 50 times the IDL for analysis done on the ICP or 100 times the IDL for analysis done on the ICP-MS. The result was flagged with the E qualifier to indicate that a physical interference was observed. |
| E | Organic | Analyte concentration exceeds calibration range. |
| F | Inorganic | Due to potential interferences for this analysis by Inductively Coupled Plasma techniques (SW-846 Method 6010), this analyte has been confirmed by and reported from an alternate method. |
| F | Organic | Surrogate results outside control criteria. |
| H | All | Preservation, extraction or analysis performed past holding time. |
| J | Inorganic | The analyte has been detected between the method detection limit and the reporting limit. |
| J | Organic | Concentration detected is greater than the method detection limit but less than the reporting limit. |
| K | Inorganic | Sample received unpreserved. Sample was either preserved at the time of receipt or at the time of sample preparation. |
| K | Organic | Detection limit may be elevated due to the presence of an unrequested analyte. |
| L | All | Elevated detection limit due to low sample volume. |
| N | All | Spiked sample recovery not within control limits. |
| P | Organic | The relative percent difference between the two columns for detected concentrations was greater than 40%. |
| Q | All | The analyte has been detected between the limit of detection (LOD) and limit of quantitation (LOQ). The results are qualified due to the uncertainty of analyte concentrations within this range. |
| S | Organic | The relative percent difference between quantitation and confirmation columns exceeds internal quality control criteria. Because the result is unconfirmed, it has been reported as a non-detect with an elevated detection limit. |
| U | All | The analyte was not detected at or above the reporting limit. |
| V | All | Sample received with headspace. |
| W | All | A second aliquot of sample was analyzed from a container with headspace. |
| X | All | See Sample Narrative. |
| & | All | Laboratory Control Spike recovery not within control limits. |
| * | All | Precision not within control limits. |
| < | All | The analyte was not detected at or above the reporting limit. |
| 1 | Inorganic | Dissolved analyte or filtered analyte greater than total analyte; analyses passed QC based on precision criteria. |
| 2 | Inorganic | Dissolved analyte or filtered analyte greater than total analyte; analyses failed QC based on precision criteria. |
| 3 | Inorganic | BOD result is estimated due to the BOD blank exceeding the allowable oxygen depletion. |
| 4 | Inorganic | BOD duplicate precision not within control limits. Due to the 48 hour holding time for this test, it is not practical to reanalyze and try to correct the deficiency. |
| 5 | Inorganic | BOD result is estimated due to insufficient oxygen depletion. Due to the 48 hour holding time for this test, it is not practical to reanalyze and try to correct the deficiency. |
| 6 | Inorganic | BOD laboratory control sample not within control limits. Due to the 48 hour holding time for this test, it is not practical to reanalyze and try to correct the deficiency. |
| 7 | Inorganic | BOD result is estimated due to complete oxygen depletion. Due to the 48 hour holding time for this test, it is not practical to reanalyze and try to correct the deficiency. |

| Test Group Name | 842713-001 | 842713-002 | 842713-003 | 842713-004 | 842713-005 | 842713-006 | 842713-007 | 842713-008 | 842713-009 |
|----------------------------|------------|------------|------------|------------|------------|------------|------------|------------|------------|
| BTEX | G | G | G | G | G | G | G | G | G |
| BTEX BLANK | G | G | G | G | G | G | G | G | G |
| DRO Extended Range C10-C40 | G | G | G | | G | G | G | G | G |
| NICKEL - DISSOLVED | G | G | G | | G | G | G | G | G |
| NITROGEN, NO3 + NO2 | K | K | K | | K | K | K | K | K |
| SULFATE | G | G | G | | G | G | G | G | G |
| VANADIUM - DISSOLVED | G | G | G | | G | G | G | G | G |

| Minnesota Certification | |
|----------------------------|----------------|
| G = En Chem Green Bay | 055-999-334 |
| K = En Chem Kimberly | 055-999-107 |
| S = En Chem Superior | Not Applicable |
| C = Subcontracted Analysis | |

Data File: \\xgb1\data2\chem\dro1.i\011304.b\005R0101.D

Date : 13-JAN-2004 10:35

Client ID: 842713-001

Sample Info: 42713E001MPX1

Volume Injected (uL): 2.0

Column phase: RTX-5/1.0.

Instrument: dro1.i

Operator: SVM

Column diameter: 0.53

\\xgb1\data2\chem\dro1.i\011304.b\005R0101.D

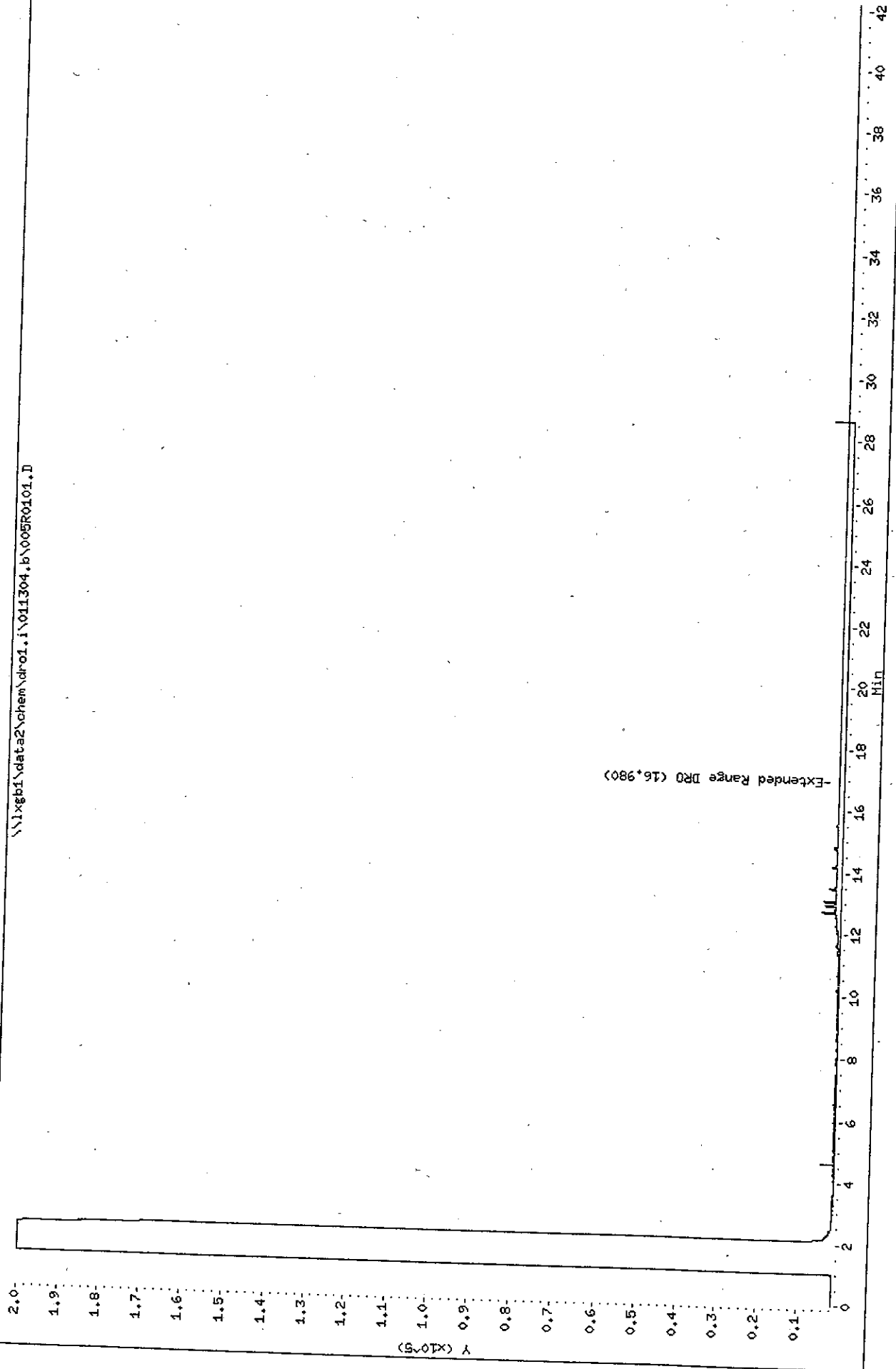

Data File: \\lxgb1\data2\chem\dro1.i\011304.b\006R0101.D

Date: 13-JUN-2004 11:23

Client ID: 842713-002

Sample Info: 42713E002MPX1

Volume Injected (uL): 2.0

Column phase: RTX-5/1.6.

Instrument: dro1.i

Operator: SVM

Column diameter: 0.53

\\lxgb1\data2\chem\dro1.i\011304.b\006R0101.D

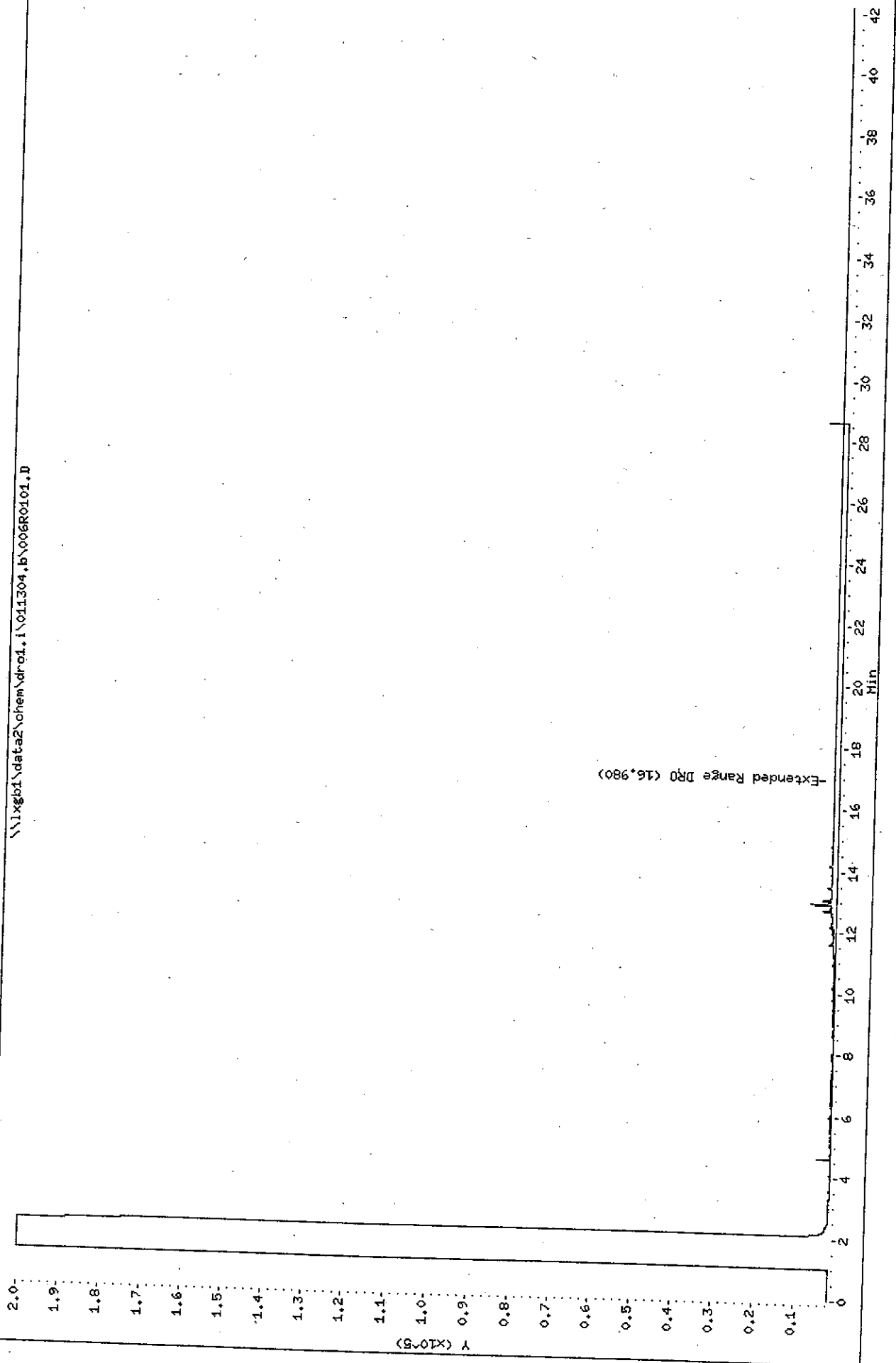

Data File: \\lxgb1\data2\chen\chro1.i\011304.b\007R0101.D

Date : 13-JAN-2004 12:10

Client ID: 842713-003

Sample Info: 42713E003HPX1

Volume Injected (uL): 2.0

Column phase: RTX-6/1.G.

Instrument: chro1.i
Operator: SVM
Column diameter: 0.53

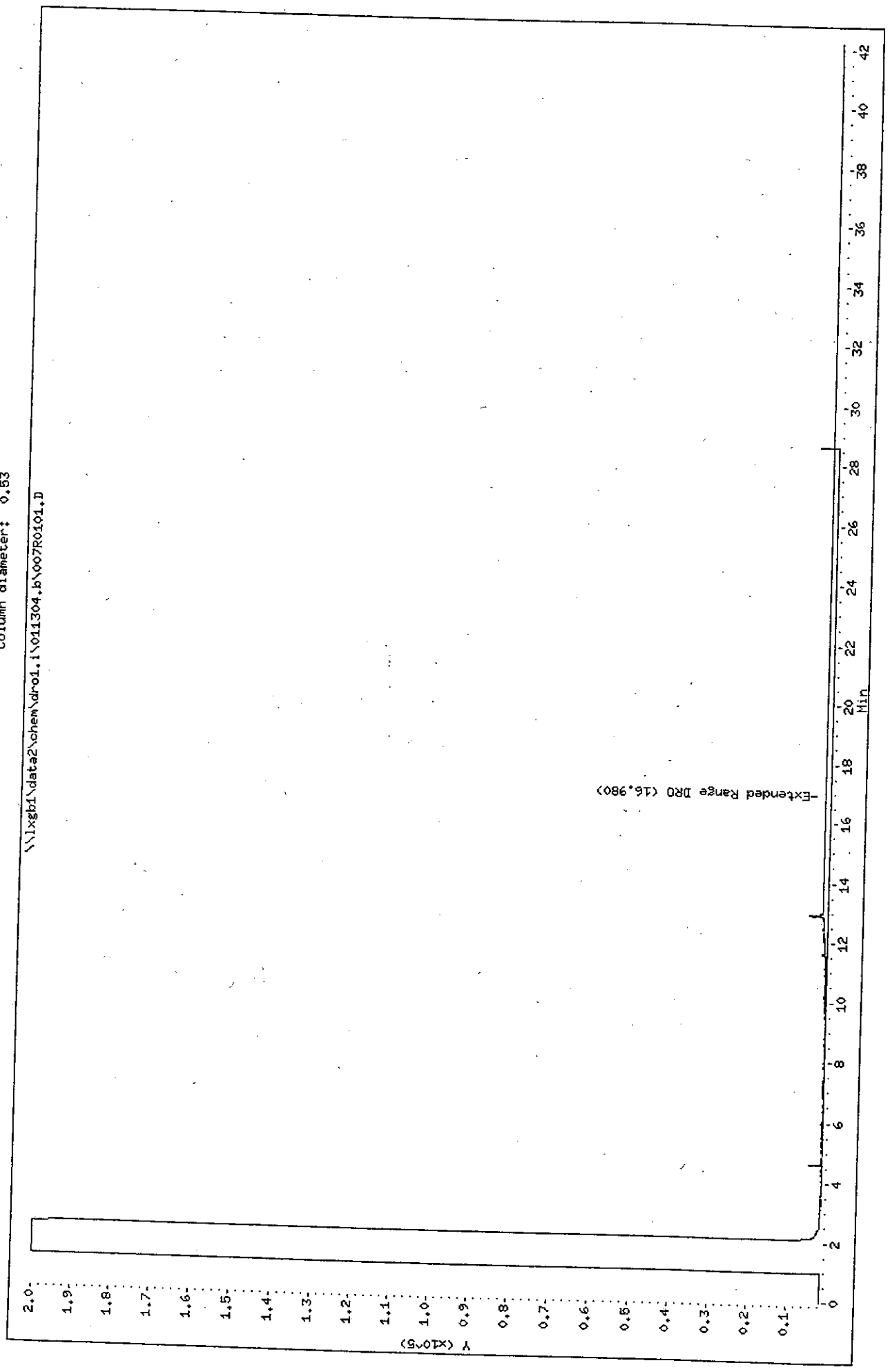

Data File: \\ixgb1\data2\chem\dro1.i\011304.b\008R0101.D

Date: 13-JAN-2004 12:58

Client ID: 842713-005

Sample Info: 42713E005MPX1

Volume Injected (uL): 2.0

Column phase: RTX-5/1.C.

Instrument: dro1.i
Operator: SVH
Column diameter: 0.53

\\ixgb1\data2\chem\dro1.i\011304.b\008R0101.D

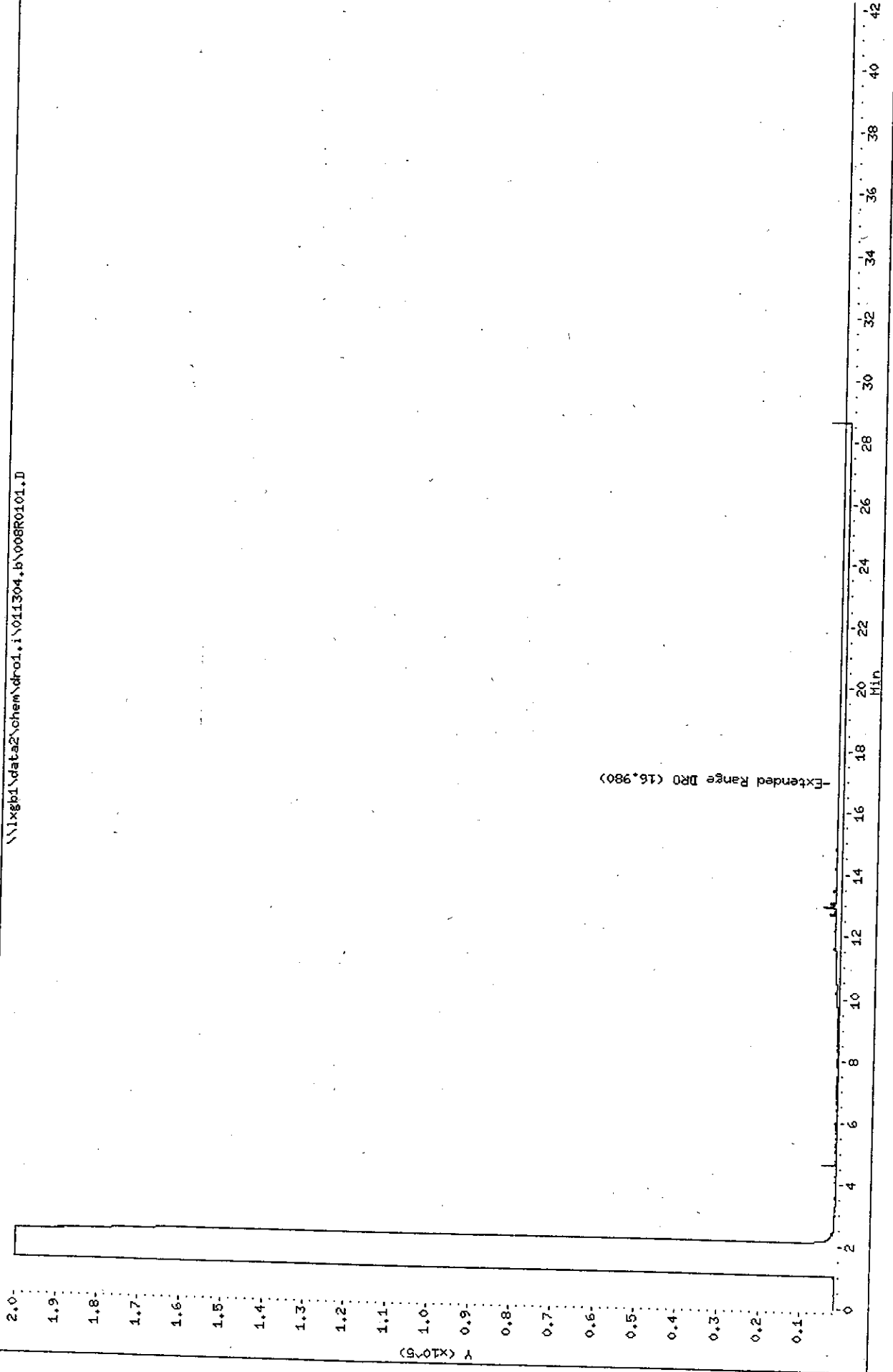

Data File: \\xgb1\data2\chem\dro1.i\011304.b\009R0101.D
Date : 13-JAN-2004 13:45
Client ID: 842713-006
Sample Info: 42713E006MPX1
Volume Injected (uL): 2.0
Column phase: RTX-5/1.0.

Instrument: dro1.i
Operator: SVM
Column diameter: 0.53

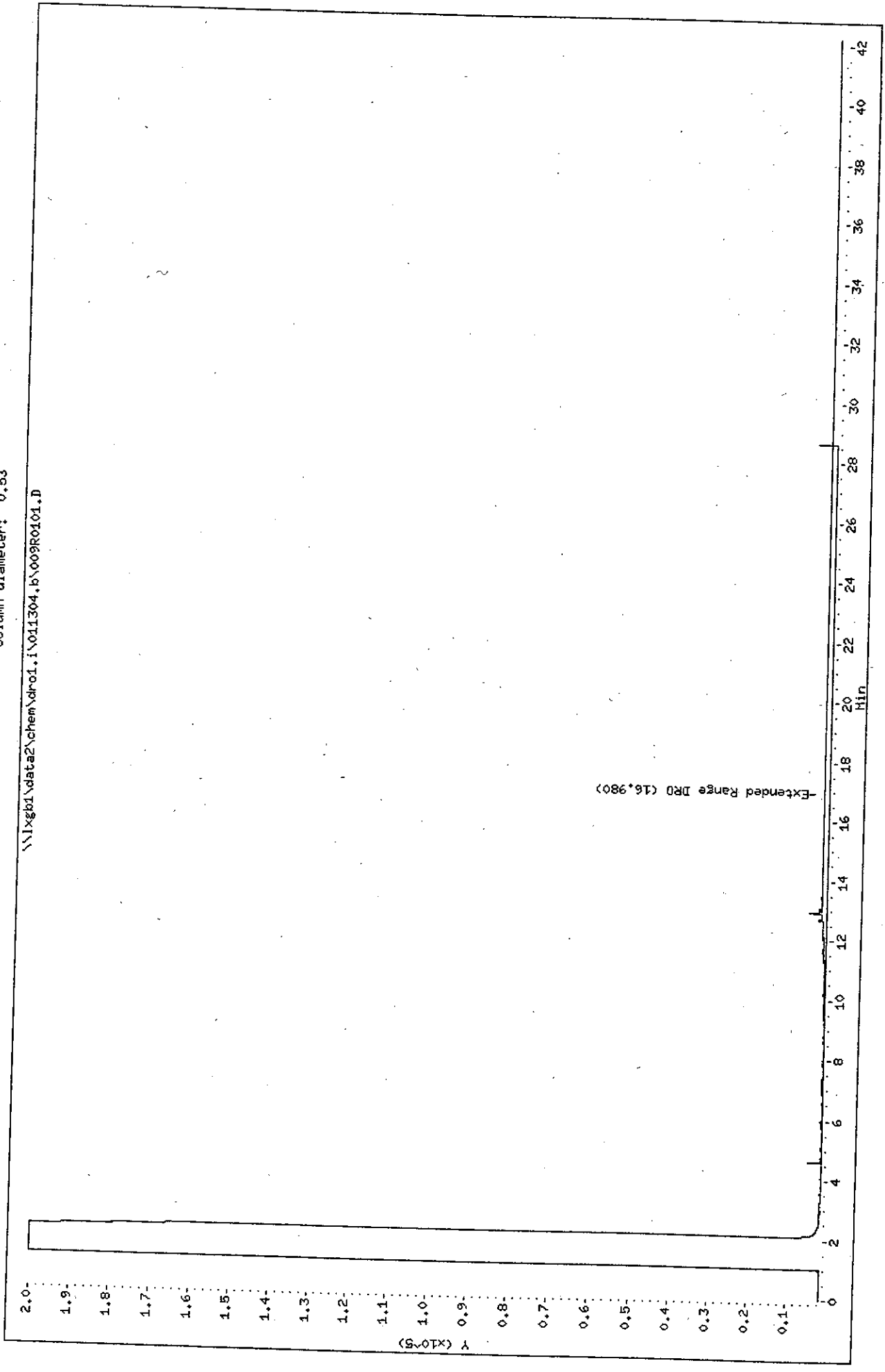

Extended Range DRD (16,980)

Data File: \\lxgb1\data2\chem\dro1.i\011304.b\010R0101.D
Date : 13-JAN-2004 14:33
Client ID: 842743-007
Sample Info: 42713E007MPX1
Volume Injected (uL): 2.0
Column phase: RTX-5/1.G.

Instrument: dro1.i
Operator: SVM
Column diameter: 0.53

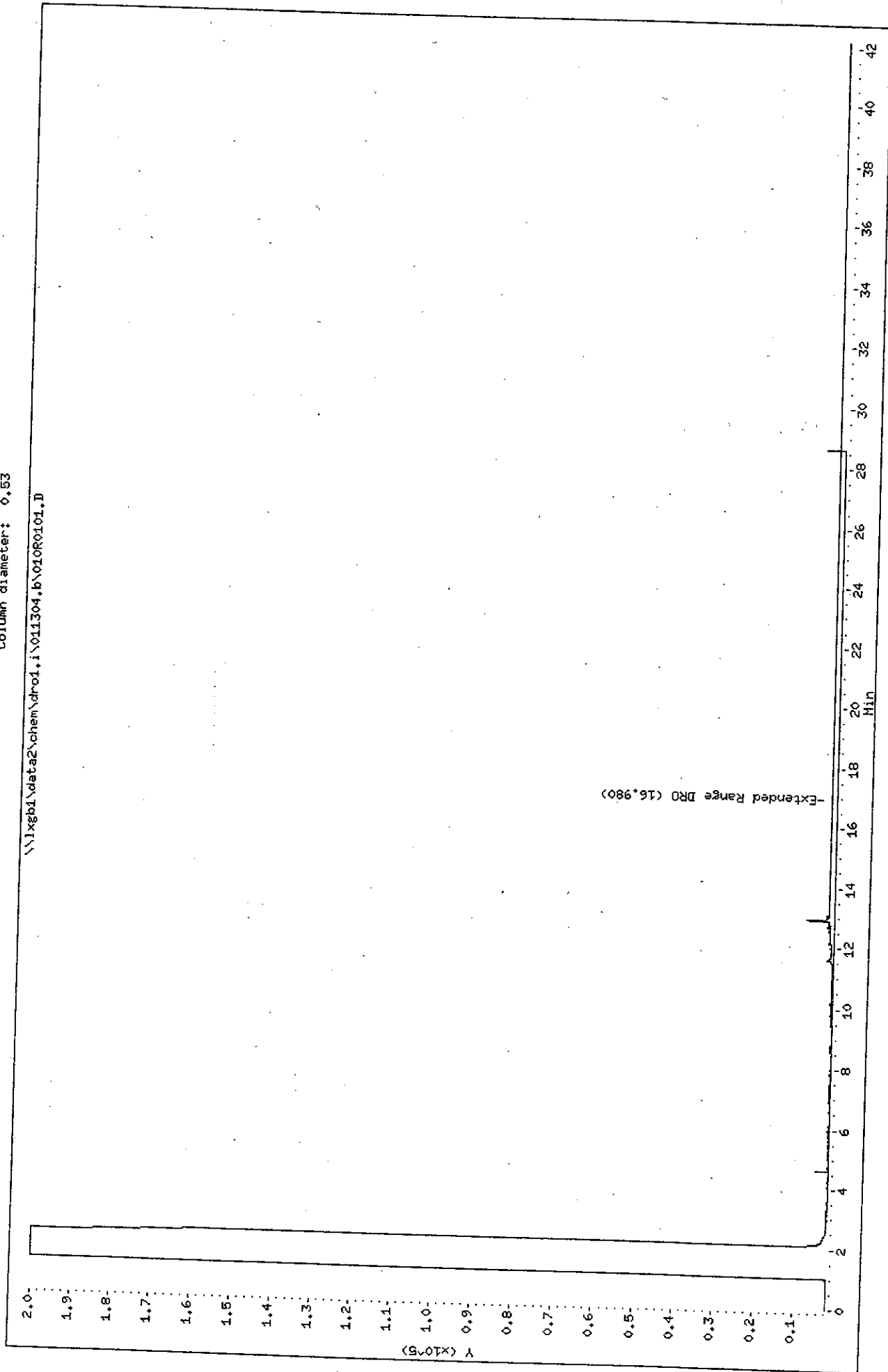

Data File: \\lxgb1\data2\chem\dro1.i\011304.b\011R0101.D

Date: 13-JAN-2004 15:21

Client ID: 842713-008

Sample Info: 42713E008MPX1

Volume Injected (uL): 2.0

Column phase: RTX-5/I.G.

Instrument: dro1.i

Operator: SVH

Column diameter: 0.53

\\lxgb1\data2\chem\dro1.i\011304.b\011R0101.D

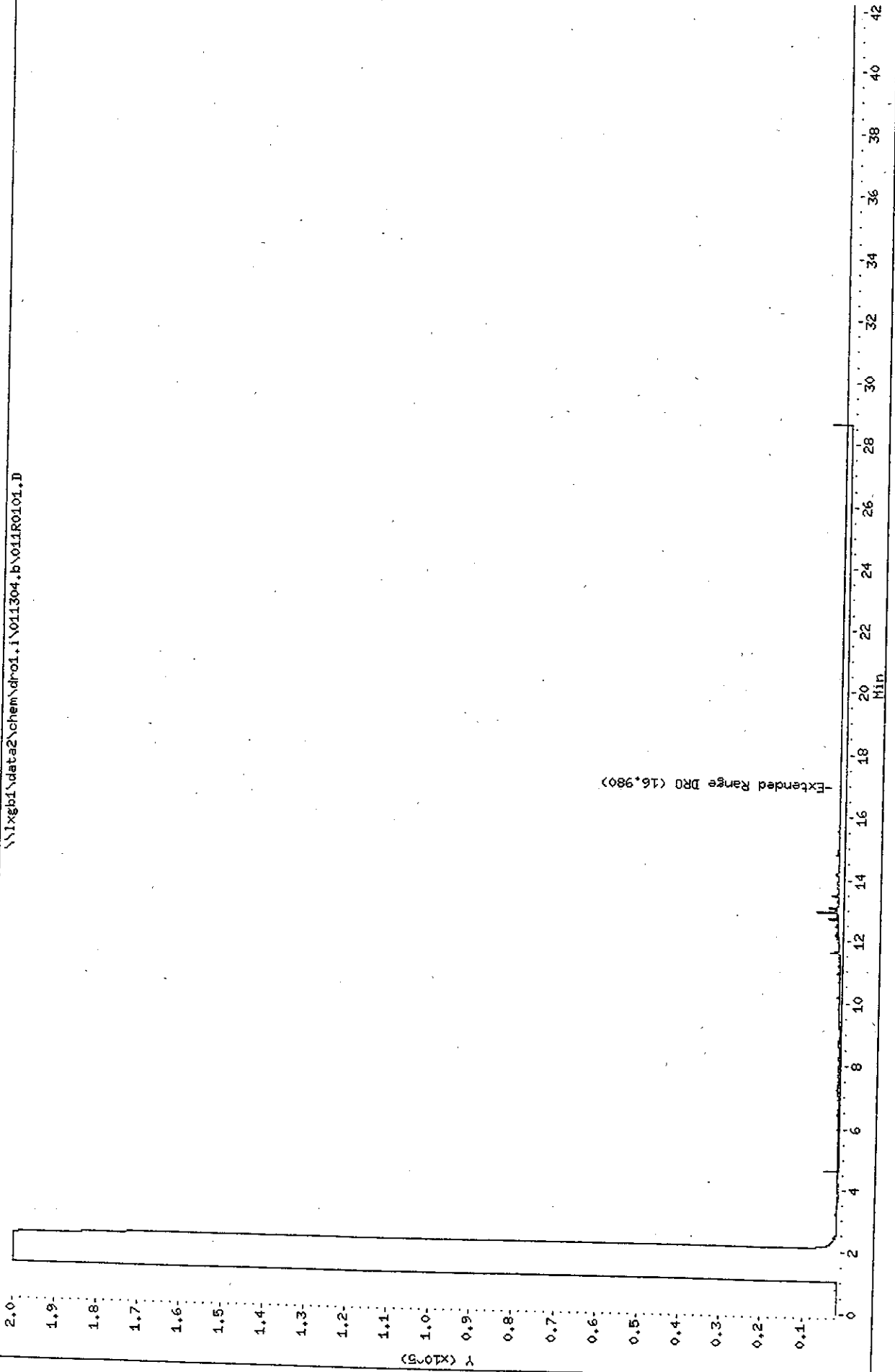

Data File: \\lxgb1\data2\chem\dro1.i\011304.b\012R0101.D

Date: 13-JAN-2004 16:08

Client ID: 842713-009

Sample Info: 42713E009WPX8

Volume Injected (uL): 2.0

Column phase: RTX-5/1.G.

Instrument: dro1.i

Operator: SVM

Column diameter: 0.53

\\lxgb1\data2\chem\dro1.i\011304.b\012R0101.D

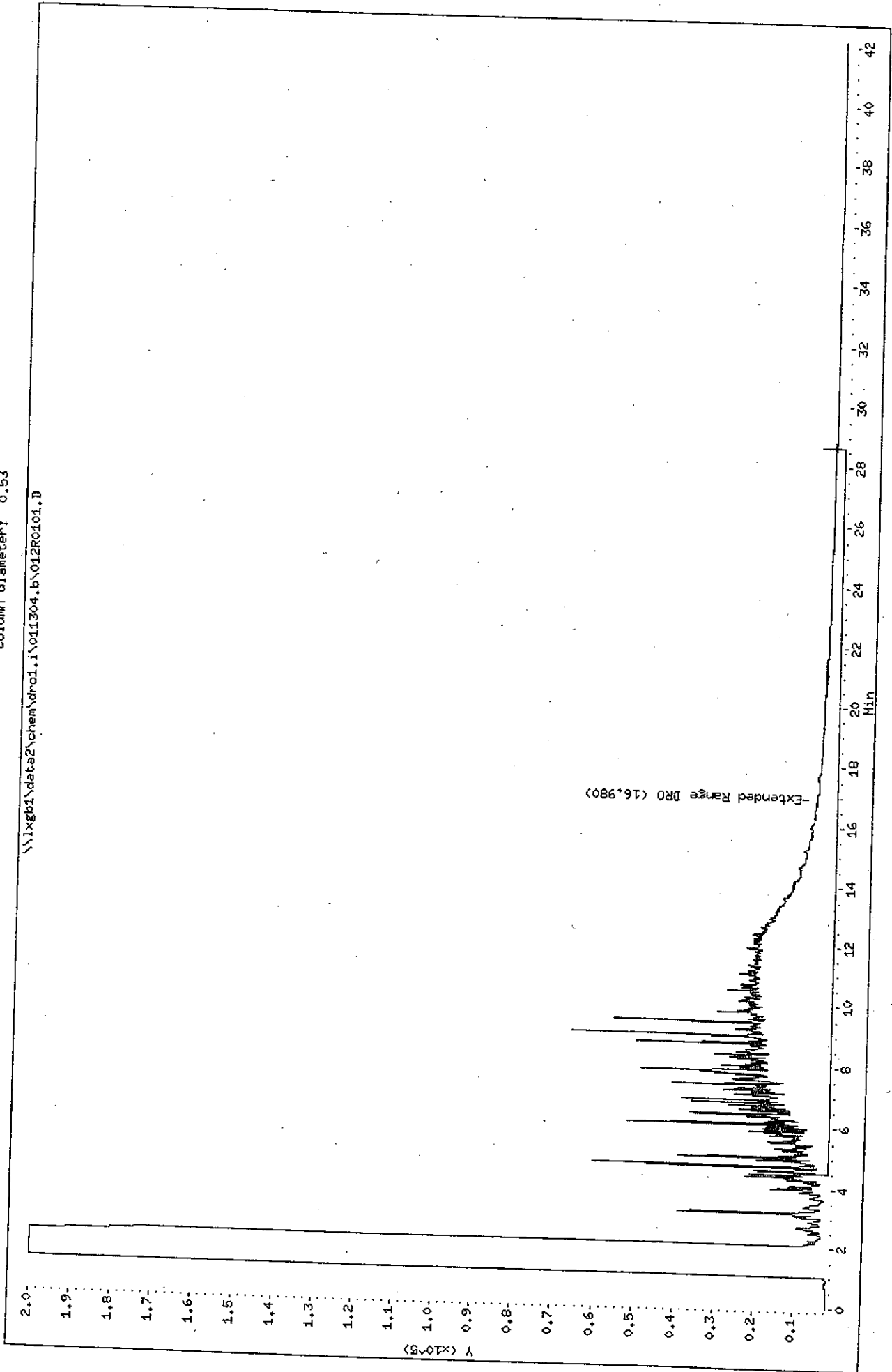

FORM 1
VOLATILE ORGANICS ANALYSIS DATA SHEET

CLIENT SAMPLE NO.

BLKA 1356-92

Lab Name: ENCHEM INC. - GREEN BAY Contract:

Lab Code: ENCHEMGB Case No.: SAS No.: SDG No.: GRO5-011204

Matrix: (soil/water) WATER Lab Sample ID: BLKA 1356-92

Sample wt/vol: _____ (g/mL) ML Lab File ID: 004F0101

Level: (low/med) LOW Date Received: _____

% Moisture: not dec. - _____ Date Analyzed: 01/12/04

GC Column: DB-624 ID: 0.32 (mm) Dilution Factor: 1.0

Soil Extract Volume: _____ (uL) Soil Aliquot Volume: _____ (uL)

| CAS NO. | COMPOUND | CONCENTRATION UNITS: (ug/L or ug/Kg) UG/L | Q |
|-----------|-------------------------|--|---|
| 1634-04-4 | Methyl tert-butyl ether | 1.00 | U |
| 71-43-2 | Benzene | 1.00 | U |
| 108-88-3 | Toluene | 1.00 | U |
| 100-41-4 | Ethylbenzene | 1.00 | U |
| 108-38-3 | m/p-Xylene | 1.00 | U |
| 95-47-6 | o-Xylene | 2.00 | U |
| 108-67-8 | 1,3,5-Trimethylbenzene | 1.00 | U |
| 95-63-6 | 1,2,4-Trimethylbenzene | 1.00 | U |
| 91-20-3 | Naphthalene | 1.00 | U |
| | Total Xylenes | 3.00 | U |

FORM 3
WATER VOLATILE MATRIX SPIKE/MATRIX SPIKE DUPLICATE RECOVERY

Lab Name: ENCHEM INC. - GREEN BAY Contract: _____
 Lab Code: ENCHEMGB Case No.: _____ SAS No.: _____ SDG No.: GRO5-011204
 Matrix Spike - Sample No.: 841900-065

Batch QC

| COMPOUND | SPIKE ADDED (ug/L) | SAMPLE CONCENTRATION (ug/L) | MS CONCENTRATION (ug/L) | MS % REC # | QC LIMITS REC. |
|-------------------------|--------------------|-----------------------------|-------------------------|------------|----------------|
| Methyl tert-butyl ether | 20.00 | 0.00 | 20.32 | 102 | 77-118 |
| Benzene | 20.00 | 3.43 | 27.13 | 118 | 62-135 |
| Toluene | 20.00 | 3.53 | 26.82 | 116 | 69-132 |
| Ethylbenzene | 20.00 | 1.05 | 24.59 | 118 | 61-137 |
| m/p-Xylene | 40.00 | 3.52 | 49.54 | 115 | 65-134 |
| o-Xylene | 20.00 | 1.41 | 24.43 | 115 | 68-132 |
| 1,3,5-Trimethylbenzene | 20.00 | 0.00 | 23.13 | 116 | 57-136 |
| 1,2,4-Trimethylbenzene | 20.00 | 1.22 | 23.58 | 112 | 59-134 |
| Naphthalene | 20.00 | 0.00 | 18.49 | 92 | 42-145 |
| Total Xylenes | 60.00 | 4.93 | 73.98 | 115 | 69-132 |

| COMPOUND | SPIKE ADDED (ug/L) | MSD CONCENTRATION (ug/L) | MSD % REC # | % RPD # | QC LIMITS RPD | REC. |
|-------------------------|--------------------|--------------------------|-------------|---------|---------------|--------|
| Methyl tert-butyl ether | 20.00 | 20.03 | 100 | 1 | 21 | 77-118 |
| Benzene | 20.00 | 26.81 | 117 | 1 | 30 | 62-135 |
| Toluene | 20.00 | 26.45 | 115 | 1 | 21 | 69-132 |
| Ethylbenzene | 20.00 | 24.23 | 116 | 1 | 22 | 61-137 |
| m/p-Xylene | 40.00 | 48.85 | 113 | 1 | 27 | 65-134 |
| o-Xylene | 20.00 | 24.04 | 113 | 2 | 21 | 68-132 |
| 1,3,5-Trimethylbenzene | 20.00 | 22.80 | 114 | 1 | 33 | 57-136 |
| 1,2,4-Trimethylbenzene | 20.00 | 23.24 | 110 | 1 | 31 | 59-134 |
| Naphthalene | 20.00 | 18.07 | 90 | 2 | 34 | 42-145 |
| Total Xylenes | 60.00 | 72.89 | 113 | 1 | 30 | 69-132 |

Column to be used to flag recovery and RPD values with an asterisk

* Values outside of QC limits

RPD: 0 out of 10 outside limits

Spike Recovery: 0 out of 20 outside limits

COMMENTS: _____

FORM 3
WATER VOLATILE BLANK SPIKE RECOVERY

Lab Name: ENCHEM INC. - GREEN BAY

Contract:

Lab Code: ENCHEMGB

Case No.:

SAS No.:

SDG No.: GRO5-011204

Matrix Spike - Sample No.: BLKA 1356-92

| COMPOUND | SPIKE ADDED (ug/L) | BLANK CONCENTRATION (ug/L) | BS CONCENTRATION (ug/L) | BS % REC # | QC LIMITS REC. |
|-------------------------|--------------------|----------------------------|-------------------------|------------|----------------|
| Methyl tert-butyl ether | 20.00 | 0.00 | 19.88 | 99 | 80-120 |
| Benzene | 20.00 | 0.00 | 21.12 | 106 | 80-120 |
| Toluene | 20.00 | 0.00 | 20.38 | 102 | 80-120 |
| Ethylbenzene | 20.00 | 0.00 | 19.93 | 100 | 80-120 |
| m/p-Xylene | 40.00 | 0.00 | 39.30 | 98 | 80-120 |
| o-Xylene | 20.00 | 0.00 | 20.33 | 102 | 80-120 |
| 1,3,5-Trimethylbenzene | 20.00 | 0.00 | 19.28 | 96 | 80-120 |
| 1,2,4-Trimethylbenzene | 20.00 | 0.00 | 19.10 | 96 | 80-120 |
| Naphthalene | 20.00 | 0.00 | 17.15 | 86 | 80-120 |
| Total Xylenes | 60.00 | 0.00 | 59.64 | 99 | 80-120 |

| COMPOUND | SPIKE ADDED (ug/L) | BSD CONCENTRATION (ug/L) | BSD % REC # | % RPD # | QC LIMITS RPD | REC. |
|-------------------------|--------------------|--------------------------|-------------|---------|---------------|--------|
| Methyl tert-butyl ether | 20.00 | 19.80 | 99 | 0 | 20 | 80-120 |
| Benzene | 20.00 | 21.48 | 107 | 2 | 20 | 80-120 |
| Toluene | 20.00 | 20.74 | 104 | 2 | 20 | 80-120 |
| Ethylbenzene | 20.00 | 20.19 | 101 | 1 | 20 | 80-120 |
| m/p-Xylene | 40.00 | 39.95 | 100 | 2 | 20 | 80-120 |
| o-Xylene | 20.00 | 20.63 | 103 | 1 | 20 | 80-120 |
| 1,3,5-Trimethylbenzene | 20.00 | 19.60 | 98 | 2 | 20 | 80-120 |
| 1,2,4-Trimethylbenzene | 20.00 | 19.33 | 97 | 1 | 20 | 80-120 |
| Naphthalene | 20.00 | 17.44 | 87 | 2 | 20 | 80-120 |
| Total Xylenes | 60.00 | 60.59 | 101 | 2 | 20 | 80-120 |

Column to be used to flag recovery and RPD values with an asterisk

* Values outside of QC limits

RPD: 0 out of 10 outside limits

Spike Recovery: 0 out of 20 outside limits

COMMENTS:

Surrogates
En Chem - Green Bay

Effective Date: 07/14/2002

| Surrogate - GC VOA | Aqueous | | Low Level Solids | | Methanol Solids | |
|--|---------|-----|------------------|-----|-----------------|-----|
| | LCL | UCL | LCL | UCL | LCL | UCL |
| α,α,α -Trifluorotoluene | 61 | 149 | 54 | 144 | 62 | 154 |

Effective Date : 12/29/03

| Surrogate - GCMS VOA | Aqueous | | Low Level Solids | | Methanol Solids | |
|------------------------|---------|-----|------------------|-----|-----------------|-----|
| | LCL | UCL | LCL | UCL | LCL | UCL |
| Dibromofluoromethane | 69 | 140 | 59 | 105 | 62 | 123 |
| Toluene-d ₈ | 72 | 137 | 63 | 118 | 73 | 123 |
| 4-Bromofluorobenzene | 65 | 133 | 66 | 119 | 44 | 107 |

Effective Date: 07/14/2002

| Surrogate - GCMS PAH | Aqueous | | Solids | |
|-----------------------------|---------|-----|--------|-----|
| | LCL | UCL | LCL | UCL |
| Nitrobenzene-d ₅ | 30 | 170 | 35 | 126 |
| 2-Fluorobiphenyl | 30 | 126 | 44 | 110 |
| Terphenyl-d ₁₄ | 56 | 148 | 38 | 145 |

Effective Date: 07/14/2002

| Surrogate - GCMS BNA | Aqueous | | Solids | |
|------------------------------------|---------|-----|--------|-----|
| | LCL | UCL | LCL | UCL |
| 2-Fluorophenol | 13 | 70 | 35 | 114 |
| Phenol-d ₅ | 8 | 44 | 29 | 114 |
| 2-Chlorophenol-d ₄ | 29 | 104 | 34 | 107 |
| 1,2-Dichlorobenzene-d ₄ | 34 | 112 | 27 | 116 |
| Nitrobenzene-d ₅ | 34 | 126 | 26 | 126 |
| 2-Fluorobiphenyl | 36 | 126 | 26 | 126 |
| 2,4,6-Tribromophenol | 39 | 133 | 17 | 129 |
| Terphenyl-d ₁₄ | 56 | 139 | 23 | 141 |

Effective Date: 07/14/2002

| Surrogate - GC PCB | Aqueous | | Solids | |
|--------------------|---------|-----|--------|-----|
| | LCL | UCL | LCL | UCL |
| Decachlorobiphenyl | 22 | 133 | 11 | 142 |

Effective Date: 07/14/2002

| Surrogate - TPH Diesel | Aqueous | | Solids | |
|------------------------|---------|-----|--------|-----|
| | LCL | UCL | LCL | UCL |
| o - Terphenyl | 33 | 133 | 34 | 106 |

Effective Date: 07/14/2002

| Surrogate - TPH Gas | Aqueous | | Solids | |
|--|---------|-----|--------|-----|
| | LCL | UCL | LCL | UCL |
| α,α,α -Trifluorotoluene | 61 | 149 | 62 | 154 |

En Chem, Inc. Cooler Receipt Log

Batch No. 842713

Project Name or ID South Cass Lake

No. of Coolers: 2 Temps: 0°C, 3.0°C

A. Receipt Phase: Date cooler was opened: 1-8-04 By: GD

- 1: Were samples received on ice? (Must be ≤ 6 C)..... YES NO²
- 2: Was there a Temperature Blank?..... YES NO
- 3: Were custody seals present and intact? (Record on COC)..... YES NO
- 4: Are COC documents present?..... YES NO²
- 5: Does this Project require quick turn around analysis?..... YES NO
- 6: Is there any sub-work?..... YES NO
- 7: Are there any short hold time tests?..... YES NO
- 8: Are any samples nearing expiration of hold-time? (Within 2 days)..... YES¹ NO Contacted by/Who SWC
- 9: Do any samples need to be Filtered or Preserved in the lab?..... YES¹ NO Contacted by/Who MV

B. Check-in Phase: Date samples were Checked-in: 1-8-04 By: GD

- 1: Were all sample containers listed on the COC received and intact?..... YES NO² NA
- 2: Sign the COC as received by En Chem. Completed..... YES NO
- 3: Do sample labels match the COC?..... YES NO²
- 4: Completed pH check on preserved samples..... YES NO NA
(This statement does not apply to water: VOC, O&G, TOC, DRO, Total Rec. Phenolics)
- 5: Do samples have correct chemical preservation?..... YES NO² NA
(This statement does not apply to water: VOC, O&G, TOC, DRO, Total Rec. Phenolics)
- 6: Are dissolved parameters field filtered?..... YES NO² NA
- 7: Are sample volumes adequate for tests requested?..... YES NO²
- 8: Are VOC samples free of bubbles >6mm..... YES NO² NA
- 9: Enter samples into logbook. Completed..... YES NO
- 10: Place laboratory sample number on all containers and COC. Completed..... YES NO
- 11: Complete Laboratory Tracking Sheet (LTS). Completed..... YES NO NA
- 12: Start Nonconformance form..... YES NO NA
- 13: Initiate Subcontracting procedure. Completed..... YES NO NA
- 14: Check laboratory sample number on all containers and COC. YES NO NA

Short Hold-time tests:

| | | |
|--|--|--|
| 48 Hours or less Coliform (6 hrs) Hexavalent Chromium (24 Hrs) BOD Nitrite or Nitrate Low Level Mercury Ortho Phosphorus Turbidity Surfactants Sulfite En Core Preservation Color | 7 days Flashpoint TSS Total Solids TDS Sulfide Free Liquids Total Volatile Solids <u>Aqueous Extractable Organics- ALL</u> Unpreserved VOC's Ash | Footnotes 1 Notify proper lab group immediately. 2 Complete nonconformance memo. |
|--|--|--|

Rev. 4/11/03, Attachment to 1-REC-5.
 Subject to QA Audit.

Reviewed by/date SB 1/12/04

Please Print Legibly

Company Name: NREC

Branch or Location: Superior, WI

Project Contact: Barry Power

Telephone: 715-395-5680

Project Number: South Cass Lake

Project Name: MN

Project State: MN

Sampled By (Print): Brian Hill

PO #:

Data Package Options - (please circle if requested)
Sample Results Only (no OC)
EPA Level II (Subject to Surcharge)
EPA Level III (Subject to Surcharge)
EPA Level IV (Subject to Surcharge)

| LABORATORY ID (Lab Use Only) | FIELD ID | COLLECTION | | Matrix Codes |
|---------------------------------|------------|------------|------|--------------|
| | | DATE | TIME | |
| 001 | MW-1 | 1/6/04 | | W |
| 002 | MW-2 | | | |
| 003 | MW-4 | | | |
| 004 | MW-5 | | | |
| 005 | MW-6 | | | |
| 006 | MW-7 | | | |
| 007 | MW-8 | | | |
| 008 | MW-9 | | | |
| 009 | MW-10 | | | |
| | Trip Blank | | | |

Rush Turnaround Time Requested (TAT) - Prelim
(Rush TAT subject to approval/surcharge)

Date Needed:

Transmit Prelim Rush Results by (circle):

Phone Fax E-Mail

Phone #:

Fax #:

E-Mail Address:

Samples on HOLD are subject to special pricing and release of liability

EN CHEM INC.

chemistry for the environment

1241 Bellevue St., Suite 9
Green Bay, WI 54302
920-469-2436
Fax 920-469-8827

CHAIN OF CUSTODY No 116514

Page 1 of 1

Quote #:

Mail Report To: Brian Hill

Company: NREC

Address: 69 N 28th St. Suite 2

Superior, WI 54880

Invoice To: Barry Power

Company: Enbridge Energy

Address:

Mail Invoice To: Brian Hill

Matrix Codes
W=Water
S=Soil
A=Air
C=Charcoal
B=Biota
SI=Sludge

Regulatory Program
UST
RCRA
SDWA
NPDES
CERCLA

Preservation Codes
A=None
H=Sodium Bisulfate Solution
I=Sodium Thiosulfate
E=EnCore
F=Methanol
G=NaOH
J=Other

Filterered? (YES/NO)
N N N N N N N N
B B A C A A

ANALYSES REQUESTED
BTEX
Sulfate + Nitrate
Nickel
Vanadium

TOTAL # OF BOTTLES SENT
7
7
7
3
7
7
7
7
7
1

CLIENT COMMENTS
Please filter 1L Am... 3-40ml B... 1-25ml A... 1-500ml A

LAB COMMENTS
(Lab Use Only)
F.P. NO 65
F.P.

Relinquished By: Conrad K... 1-8-04

Relinquished By: Don Harber 1-8-04 14:30

Relinquished By: Dunham

Relinquished By:

Relinquished By:

Received By: Don Harber 1-8-04 09:55

Received By: Dunham 1-8-04 14:30

Received By: Don Harber 1-9-04 0835

Received By:

Received By:

Date/Time: 1-8-04 14:30

Date/Time: 1-8-04 14:30

Date/Time: 1-9-04 0835

Date/Time:

Date/Time:

En Chem Project No. 842713

Sample Receipt Temp. 0°C, 3.0°C

Sample Receipt pH (wet/meas) OK

Cooler Custody Seal Present / Not Present

Intact / Not Intact

1-250ml Added For Filtered Sample 1/6/04